

**CUTTING RING  
FITTINGS**

**6**



6

## HYDROSCAND CUTTING RING FITTINGS

### PRODUCT GROUP 600

Hydroscand's cutting ring fittings are used for tubing, mainly in hydraulic and pneumatic applications. Hydroscand can also offer a stainless steel cutting ring fitting designed for aggressive media and surroundings. Working pressure/PN up to 63 MPa/630 Bar, for male pipes of 4–42 mm diameter. Pressure ratings according to ISO 8434-1.

Cutting ring fittings are characterised by a very rigid tube assembling, resistance to vibrations and pressure impulses. The fittings can be dismantled/reassembled more than once.

When assembling the cutting ring fitting, the ring's two edges are pressed into the pipe, which gives a mechanical bearing. The first edge has already started the penetration before the second edge starts cutting into the pipe. After the assembling, part three of the cutting ring is pushed in between the cone and the pipe, to make sure no vibrations are transported to the cutting edges. The fourth part secures radial movement. The design of the ring profile gives a very strong, axial and radial bearing. The tension is carried by the whole cutting ring length.

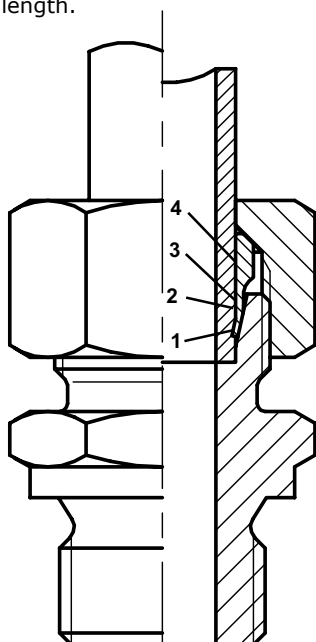

### MATERIALS

Hydroscand's cutting ring fittings are manufactured of automatic steel or of forged materials. The standard surface treatment is E-coated. E-coated is the name of the surface treatment Hydroscand use for its fittings. It is Cr<sup>6</sup> free and therefore more environmentally friendly and better for human health.

Temperatures up to +200°C. Sealing with standard NBR maximum +90°C.

### CONNECTIONS

Whitworth pipe thread G, cone pipe threads R, NPTF cone, UNF, metric. Cutting ring cone according to ISO 8434-1.

### CERTIFICATIONS

Hydroscand can deliver fittings with the following standards/certificates: DVGW, Norske Veritas, Germanischer Lloyd, ISO 9002.

### TABLE OF CONTENTS



CUTTING RING FITTINGS		PAGE
6171	GE – R/C LL	258
6172	GE – MK/C LL	258
6177	GE – NPT LL	258
6173	WE – R/C LL	258
6174	WE – MK/C LL	258
6175	WE – NPT LL	258
6182	TE – R/C LL	258
6181	TE – MK/C LL	258
6184	LE – R/C LL	258
6183	LE – MK/C LL	259
6176	G LL	259
6178	W LL	259
6187	T LL	259
6188	K LL	259
6189	RED LL	259
6186	WHO – G LL	259
6185	SWVE – M LL	259
6179	D LL	259
6180	M LL	259
6003/6503	GE – GB	260
6009/6509	GE – G/ED	260
6010/6510	GE – M/ED	261
6007/6507	GE – NPT	261
6008/6508	GE – UNF	262
6011/6511	WE – R/C	262
6013/6513	WE – GB	262
6014/6514	WE – MKC	262
6016/6516	WE – MB	263
6017/6517	WE – NPT	263
6012/6512	WEE – G	263
6018/6518	VEE – G	263
6022/6522	TEE – GB	264
6021/6521	TE – R/C	264
6023/6523	TE – GB	264
6025/6525	TEE – M	264
6024	TE – M	264
6027	TE – NPT	264
6026/6526	TEE – UNF	265
6029/6529	LEE – G	265
6031/6531	LE – R/C	265
6033/6533	LE – GB	265
6036	LE – MB	265
6030/6530	LEE – M	266
6032/6532	LEE – UNF	266
6035/6535	DKLO	266
6235	DKLO – DKSO	266
6041/6541	G	267
6042/6542	W	267
6043/6543	T	267
6044/6544	K	267
6045/6545	SV	268
6046/6546	WSV	268
6047/6547	AS	268
6048/6548	ESV	268
6049/6549	WAS	269
6051/6551	EVW – O	269
6061/6561	EVT – O	269
6071/6571	EVL – O	269
6090/6590	EVGEO – G/ED	270
6092/6592	EVGEO – M/ED	270
6101/6601	GAI – G	270
6102/6602	GAI – M	270
6103/6603	MAV – G	271
6204/6704	MAVO – EV G	271





## CUTTING RING FITTINGS

## PAGE

6055/6555	EV - O	271
6105/6605	RED	271
6109/6609	KOR - O	272
6110/6610	WHB - G	272
6111/6611	WHB - M	273
6119/6619	WHO - M	273
6118/6618	WHO - G	273
6112/6612	DSVW - G	273
6114/6614	DSVT - G	274
6116/6616	WHBT - G	274
6120/6620	RHD	274
6121/6621	RHV - G	275
6123/6623	RHZ - G - ED	275
6126	RHR	275
6130/6630	PL	275
6131/6631	Adaptor kit	275
6149/6649	D	276
6150/6650	M	276
6151/6651	FM	276
6152/6652	D - ED B4	276
6153	GM-Locking nut	277
6160	SN	277
6160-50	O-ring for 6160	277
6154-00	ED-seal NBR	277
6154-01	ED-seal Viton	277

**PRESSURE RATINGS FOR CUTTING RING FITTINGS**

			LL				L							S												
			4	5	6	8	6	8	10	12	15	18	22	28	35	42	6	8	10	12	14	16	20	25	30	38
6001	6003	6031																								
6007	6008	6009																								
6010	6011	6013																								
6014	6016	6017																								
6021	6024	6027																								
6055	6035	6036																								
6041	6042	6043																								
6044	6045	6046																								
6047	6048	6049	100																							
6050	6051	6204																								
6061	6070	6071																								
6087	6089	6090																								
6092	6101	6102																								
6105	6107	6109																								
6130	6185	6216																								
6217	6218	6219																								
6537	6126																									
6088	6172	6171																								
6171	6173	6171																								
6175	6176	6177	100																							
6178	6181	6183																								
6184	6185	6186																								
6187	6188	3189																								
6110	6111	6116																								
6118	6119																									
6103	6104																									
6018	6012	6022																								
6029																										
6023	6033																									
6112	6114																									
6118	6119		100																							
6025	6030																									
6032																										
6120	6121	6123																								

\*) safety factor 1:3

\*\*) safety factor min 1,6

**THREADS**

Pipe size	Thread
4 LL	M 8 x 1,0
4 LL	M 10 x 1,0
6 LL	M 10 x 1,0
8 LL	M 12 x 1,0
10 LL	M 14 x 1,0
12 LL	M 16 x 1,0
6 L	M 12 x 1,5
8 L	M 14 x 1,5
10 L	M 16 x 1,5
12 L	M 18 x 1,5
15 L	M 22 x 1,5
18 L	M 26 x 1,5
22 L	M 30 x 2,0
28 L	M 36 x 2,0
35 L	M 45 x 2,0
42 L	M 52 x 2,0
6 S	M 14 x 1,5
8 S	M 16 x 1,5
10 S	M 18 x 1,5
12 S	M 20 x 1,5
14 S	M 22 x 1,5
16 S	M 24 x 1,5
20 S	M 30 x 2,0
25 S	M 36 x 2,0
30 S	M 42 x 2,0
38 S	M 52 x 2,0



## ASSEMBLY INSTRUCTIONS

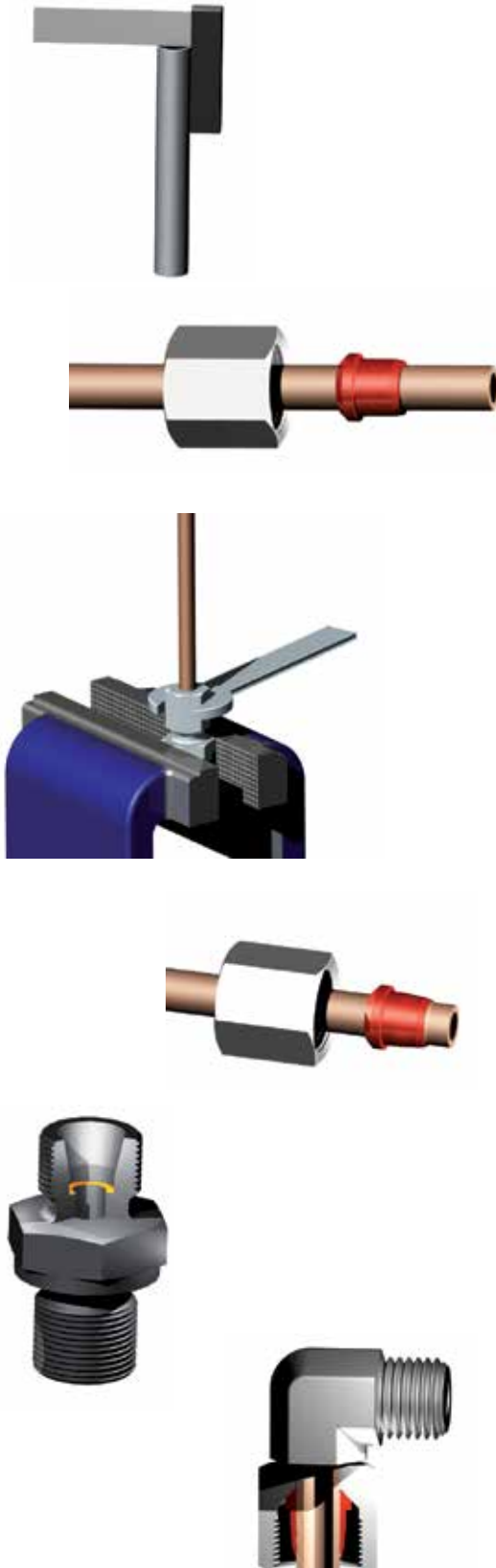

1. Cut the tube at a 90 degree angle (do not use roller, type tube cutters), remove all internal and external burrs.
2. Oil the 24° cone, the thread of the fitting body, the cutting ring and the nut. For carbon steel fittings, use mineral oil. For stainless steel fittings, use Hydroscands special oil, part number 5650-00-05.
3. Fit the nut and the cutting ring on the tubes as shown. The larger diameter of the cutting ring must face the nut.
4. Insert the tube on the 24° cone until it comes into contact with the stop. Tighten the nut by hand until the cutting ring rest firmly on the nut. Then tighten the nut with a wrench until the cutting edge of the ring is in contact with the tube and prevents rotation if this.
5. Holding the tube against its stop and making sure it does not rotate, tighten the nut by  $\frac{3}{4}$  of a turn. This way, the cutting ring cut into the outer part of the tube for the necessary depth and raises an edge in front of its cutting edge while the second cutting edge clinches the tube at the same time.
6. Loosen the nut and check that there is a clearly raised edge all round the tube. The edge must cover 80% of the front of the cutting ring. This check is peremptory for the safety of all concerned. If the raised edge is not satisfactory, pre-assembly must be repeated. The cutting ring can rotate on the tube. This is normal and does not affect the density.
7. Final assembly.

Reassemble the nut on the fitting until a certain resistance is encountered and then tighten for a further  $\frac{1}{4}$  turn.

**Final assembly of pre-assembled fittings**

Screw the nut by hand as hard as you can, then the nut should be tightened approximately  $\frac{1}{2}$ – $\frac{3}{4}$  turn more. This information apply to all our pre-installed fittings.

All the pre-assembly of stainless steel fittings must be performed with a pre-assembly tool (blocks or machines). For best results, use Hydroscands special oil, part number 5650-00-05.

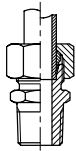

**6171**  
**GE – R/C LL**  
 Straight fitting – R M  
 Cone sealing  
**PRODUCT GROUP 600**

Part number	Type	Pipe size	Thread
6171-04-02	GE 4 LL	4 mm	R 1/8"
6171-05-02	GE 5 LL	5 mm	R 1/8"
6171-06-02	GE 6 LL	6 mm	R 1/8"
6171-08-02	GE 8 LL	8 mm	R 1/8"
6171-10-04	GE 10 LL	10 mm	R 1/4"
6171-12-04	GE 12 LL	12 mm	R 1/4"

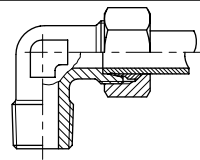

**6174**  
**WE – MK/C LL**  
 90° elbow fitting – MK M  
 Cone sealing  
**PRODUCT GROUP 600**

Part number	Type	Pipe size	Thread
6174-04-06	WE 4 LL	4 mm	M 6 x 1 k
6174-04-08	WE 4 LL	4 mm	M 8 x 1 k
6174-05-08	WE 5 LL	5 mm	M 8 x 1 k
6174-06-06	WE 6 LL	6 mm	M 6 x 1 k
6174-06-08	WE 6 LL	6 mm	M 8 x 1 k
6174-06-10	WE 6 LL	6 mm	M 10 x 1 k
6174-08-10	WE 8 LL	8 mm	M 10 x 1 k

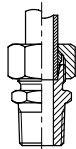

**6172**  
**GE – MK/C LL**  
 Straight fitting – MK M  
 Cone sealing  
**PRODUCT GROUP 600**

Part number	Type	Pipe size	Thread
6172-04-06	GE 4 LL	4 mm	M 6 x 1 k
6172-04-08	GE 4 LL	4 mm	M 8 x 1 k
6172-05-08	GE 5 LL	5 mm	M 8 x 1 k
6172-06-06	GE 6 LL	6 mm	M 6 x 1 k
6172-06-08	GE 6 LL	6 mm	M 8 x 1 k
6172-06-10	GE 6 LL	6 mm	M 10 x 1 k
6172-08-08	GE 8 LL	8 mm	M 8 x 1 k
6172-08-10	GE 8 LL	8 mm	M 10 x 1 k

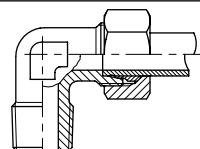

**6175**  
**WE – NPT LL**  
 90° elbow fitting – NPT M  
 Cone sealing  
**PRODUCT GROUP 600**

Part number	Type	Pipe size	Thread
6175-04-02	WE 4 LL	4 mm	1/8"-27 NPT
6175-05-02	WE 5 LL	5 mm	1/8"-27 NPT
6175-06-02	WE 6 LL	6 mm	1/8"-27 NPT
6175-08-02	WE 8 LL	8 mm	1/8"-27 NPT

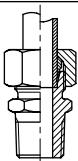

**6177**  
**GE – NPT LL**  
 Straight fitting – NPT M  
 Cone sealing  
**PRODUCT GROUP 600**

Part number	Type	Pipe size	Thread
6177-04-02	GE 4 LL	4 mm	1/8"-27 NPT
6177-05-02	GE 5 LL	5 mm	1/8"-27 NPT
6177-06-02	GE 6 LL	6 mm	1/8"-27 NPT
6177-08-02	GE 8 LL	8 mm	1/8"-27 NPT

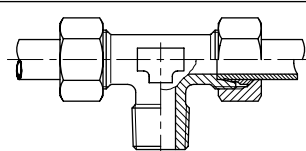

**6182**  
**TE – R/C LL**  
 T-fitting – R M  
 Cone sealing  
**PRODUCT GROUP 600**

Part number	Type	Pipe size	Thread
6182-04-02	TE 4 LL	4 mm	R 1/8"
6182-05-02	TE 5 LL	5 mm	R 1/8"
6182-06-02	TE 6 LL	6 mm	R 1/8"
6182-08-02	TE 8 LL	8 mm	R 1/8"

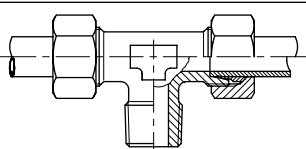

**6181**  
**TE – MK/C LL**  
 T-fitting – MK M  
 Cone sealing  
**PRODUCT GROUP 600**

Part number	Type	Pipe size	Thread
6181-04-08	TE 4 LL	4 mm	M8 x 1 k
6181-05-08	TE 5 LL	5 mm	M8 x 1 k
6181-06-10	TE 6 LL	6 mm	M10 x 1 k
6181-08-10	TE 8 LL	8 mm	M10 x 1 k

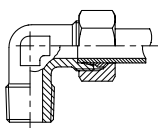

**6173**  
**WE – R/C LL**  
 Elbow fitting – R M  
 Cone sealing  
**PRODUCT GROUP 600**

Part number	Type	Pipe size	Thread
6173-04-02	WE 4 LL	4 mm	R 1/8"
6173-05-02	WE 5 LL	5 mm	R 1/8"
6173-06-02	WE 6 LL	6 mm	R 1/8"
6173-08-02	WE 8 LL	8 mm	R 1/8"
6173-10-04	WE 10 LL	10 mm	R 1/4"
6173-12-04	WE 12 LL	12 mm	R 1/4"

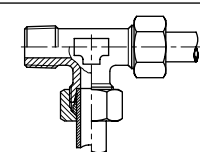

**6184**  
**LE – R/C LL**  
 L-fitting – R M  
 Cone sealing  
**PRODUCT GROUP 600**

Part number	Type	Pipe size	Thread
6184-04-02	LE 4 LL	4 mm	R 1/8"
6184-05-02	LE 5 LL	5 mm	R 1/8"
6184-06-02	LE 6 LL	6 mm	R 1/8"
6184-08-02	LE 8 LL	8 mm	R 1/8"



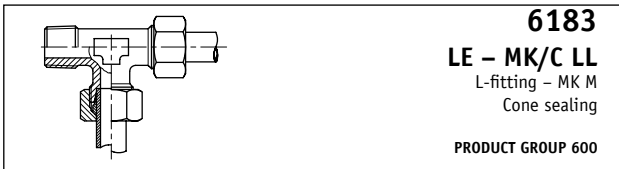

**6183**  
**LE – MK/C LL**  
L-fitting – MK M  
Cone sealing  
PRODUCT GROUP 600

Part number	Type	Pipe size	Thread
6183-04-08	LE 4 LL	4 mm	M8 x 1 k
6183-05-08	LE 5 LL	5 mm	M8 x 1 k
6183-06-10	LE 6 LL	6 mm	M10 x 1 k
6183-08-10	LE 8 LL	8 mm	M10 x 1 k

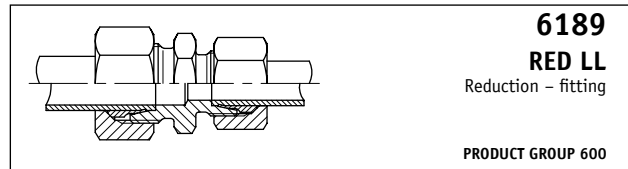

**6189**  
**RED LL**  
Reduction – fitting  
PRODUCT GROUP 600

Part number	Type	Pipe size
6189-06-04	RED 6 / 4 LL	6 - 4 mm
6189-08-04	RED 8 / 4 LL	8 - 4 mm
6189-08-06	RED 8 / 6 LL	8 - 6 mm

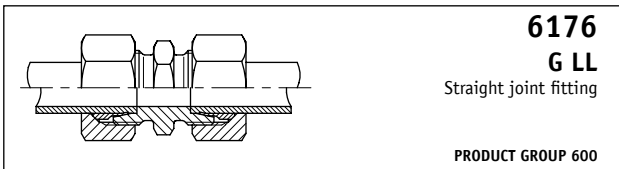

**6176**  
**G LL**  
Straight joint fitting  
PRODUCT GROUP 600

Part number	Type	Pipe size
6176-04-04	G 4 LL	4 mm
6176-05-05	G 5 LL	5 mm
6176-06-06	G 6 LL	6 mm
6176-08-08	G 8 LL	8 mm
6176-10-10	G 10 LL	10 mm
6176-12-12	G 12 LL	12 mm

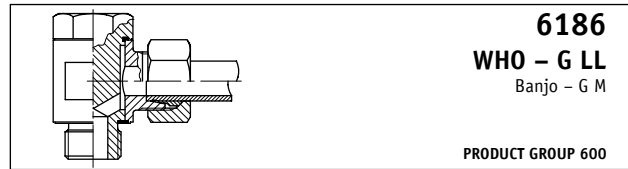

**6186**  
**WHO – G LL**  
Banjo – G M  
PRODUCT GROUP 600

Part number	Type	Pipe size	Thread
6186-04-02	WHO 4 LL	4 mm	G 1/8"
6186-05-02	WHO 5 LL	5 mm	G 1/8"
6186-06-02	WHO 6 LL	6 mm	G 1/8"
6186-08-02	WHO 8 LL	8 mm	G 1/8"



**6178**  
**W LL**  
Elbow joint fitting  
PRODUCT GROUP 600

Part number	Type	Pipe size
6178-04-04	W 4 LL	4 mm
6178-05-05	W 5 LL	5 mm
6178-06-06	W 6 LL	6 mm
6178-08-08	W 8 LL	8 mm
6178-10-10	W 10 LL	10 mm
6178-12-12	W 12 LL	12 mm

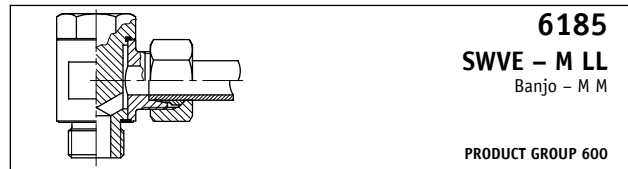

**6185**  
**SWVE – M LL**  
Banjo – M M  
PRODUCT GROUP 600

Part number	Type	Pipe size	Thread
6185-04-08	SWVE 4 LL	4 mm	M 8 x 1.0
6185-05-08	SWVE 5 LL	5 mm	M 8 x 1.0
6185-06-10	SWVE 6 LL	6 mm	M 10 x 1.0
6185-08-10	SWVE 8 LL	8 mm	M 10 x 1.0

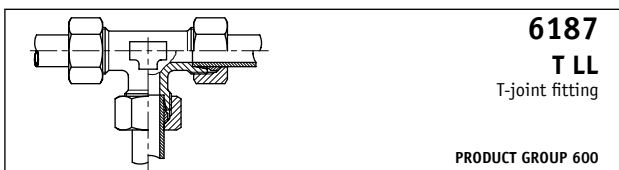

**6187**  
**T LL**  
T-joint fitting  
PRODUCT GROUP 600

Part number	Type	Pipe size
6187-04-04	T 4 LL	4 mm
6187-05-05	T 5 LL	5 mm
6187-06-06	T 6 LL	6 mm
6187-08-08	T 8 LL	8 mm
6187-10-10	T 10 LL	10 mm
6187-12-12	T 12 LL	12 mm



**6179**  
**D LL**  
Cutting ring  
PRODUCT GROUP 600

Part number	Type	Pipe size
6179-00-04	D 4 LL	4 mm
6179-00-05	D 5 LL	5 mm
6179-00-06	D 6 LL	6 mm
6179-00-08	D 8 LL	8 mm
6179-00-10	D 10 LL	10 mm
6179-00-12	D 12 LL	12 mm

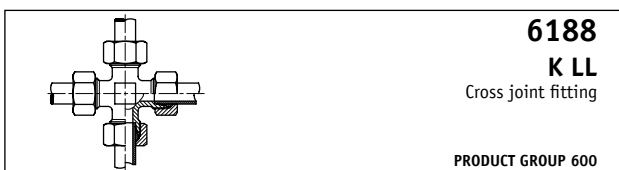

**6188**  
**K LL**  
Cross joint fitting  
PRODUCT GROUP 600

Part number	Type	Pipe size
6188-04-04	K 4 LL	4 mm
6188-06-06	K 6 LL	6 mm
6188-08-08	K 8 LL	8 mm



**6180**  
**M LL**  
Nut  
PRODUCT GROUP 600

Part number	Type	Pipe size	Thread
6180-00-04	M 4 LL	4 mm	M 8 x 1.0
6180-00-05	M 5 LL	5 mm	M 10 x 1.0
6180-00-06	M 6 LL	6 mm	M 10 x 1.0
6180-00-08	M 8 LL	8 mm	M 14 x 1.0
6180-00-10	M 10 LL	10 mm	M 14 x 1.0
6180-00-12	M 12 LL	12 mm	M 16 x 1.0

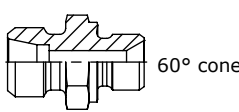

**6003/6503**  
**GE-GB**  
 Straight fitting - G M  
 Body  
 ISO 1179-4  
**PRODUCT GROUP 600**

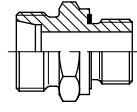

**6009/6509**  
**GE-G/ED**  
 Straight fitting - G M  
 Body  
 ISO 1179-2  
**PRODUKTGRUPP 600**

Part number	Type	Pipe size	Thread
6003-06-03	GE 6 L	6 mm	G 1/8"
6003-06-05	GE 6 L	6 mm	G 1/4"
6003-06-07	GE 6 L	6 mm	G 3/8"
6003-08-03	GE 8 L	8 mm	G 1/8"
6003-08-05	GE 8 L	8 mm	G 1/4"
6003-08-07	GE 8 L	8 mm	G 3/8"
6003-08-09	GE 8 L	8 mm	G 1/2"
6003-10-03	GE 10 L	10 mm	G 1/8"
6003-10-05	GE 10 L	10 mm	G 1/4"
6003-10-07	GE 10 L	10 mm	G 3/8"
6003-10-09	GE 10 L	10 mm	G 1/2"
6003-12-05	GE 12 L	12 mm	G 1/4"
6003-12-07	GE 12 L	12 mm	G 3/8"
6003-12-09	GE 12 L	12 mm	G 1/2"
6003-15-07	GE 15 L	15 mm	G 3/8"
6003-15-09	GE 15 L	15 mm	G 1/2"
6003-15-13	GE 15 L	15 mm	G 3/4"
6003-18-07	GE 18 L	18 mm	G 3/8"
6003-18-09	GE 18 L	18 mm	G 1/2"
6003-18-13	GE 18 L	18 mm	G 3/4"
6003-22-09	GE 22 L	22 mm	G 1/2"
6003-22-13	GE 22 L	22 mm	G 3/4"
6003-22-17	GE 22 L	22 mm	G 1"
6003-28-13	GE 28 L	28 mm	G 3/4"
6003-28-17	GE 28 L	28 mm	G 1"
6003-35-17	GE 35 L	35 mm	G 1"
6003-35-21	GE 35 L	35 mm	G 1 1/4"
6003-42-21	GE 42 L	42 mm	G 1 1/4"
6003-42-25	GE 42 L	42 mm	G 1 1/2"
6503-06-05	GE 6 S	6 mm	G 1/4"
6503-08-05	GE 8 S	8 mm	G 1/4"
6503-08-07	GE 8 S	8 mm	G 3/8"
6503-10-05	GE 10 S	10 mm	G 1/4"
6503-10-07	GE 10 S	10 mm	G 3/8"
6503-10-09	GE 10 S	10 mm	G 1/2"
6503-12-05	GE 12 S	12 mm	G 1/4"
6503-12-07	GE 12 S	12 mm	G 3/8"
6503-12-09	GE 12 S	12 mm	G 1/2"
6503-14-07	GE 14 S	14 mm	G 3/8"
6503-14-09	GE 14 S	14 mm	G 1/2"
6503-16-07	GE 16 S	16 mm	G 3/8"
6503-16-09	GE 16 S	16 mm	G 1/2"
6503-16-13	GE 16 S	16 mm	G 3/4"
6503-20-09	GE 20 S	20 mm	G 1/2"
6503-20-13	GE 20 S	20 mm	G 3/4"
6503-20-17	GE 20 S	20 mm	G 1"
6503-25-13	GE 25 S	25 mm	G 3/4"
6503-25-17	GE 25 S	25 mm	G 1"
6503-30-17	GE 30 S	30 mm	G 1"
6503-30-21	GE 30 S	30 mm	G 1 1/4"
6503-38-17	GE 38 S	38 mm	G 1"
6503-38-21	GE 38 S	38 mm	G 1 1/4"
6503-38-25	GE 38 S	38 mm	G 1 1/2"

Part number	Type	Pipe size	Thread
6009-06-03	GE 6 L	6 mm	G 1/8"
6009-06-05	GE 6 L	6 mm	G 1/4"
6009-08-03	GE 8 L	8 mm	G 1/8"
6009-08-05	GE 8 L	8 mm	G 1/4"
6009-08-07	GE 8 L	8 mm	G 3/8"
6009-08-09	GE 8 L	8 mm	G 1/2"
6009-10-03	GE 10 L	10 mm	G 1/8"
6009-10-05	GE 10 L	10 mm	G 1/4"
6009-10-07	GE 10 L	10 mm	G 3/8"
6009-10-09	GE 10 L	10 mm	G 1/2"
6009-12-05	GE 12 L	12 mm	G 1/4"
6009-12-07	GE 12 L	12 mm	G 3/8"
6009-12-09	GE 12 L	12 mm	G 1/2"
6009-15-07	GE 15 L	15 mm	G 3/8"
6009-15-09	GE 15 L	15 mm	G 1/2"
6009-15-13	GE 15 L	15 mm	G 3/4"
6009-18-07	GE 18 L	18 mm	G 3/8"
6009-18-09	GE 18 L	18 mm	G 1/2"
6009-18-13	GE 18 L	18 mm	G 3/4"
6009-22-09	GE 22 L	22 mm	G 1/2"
6009-22-13	GE 22 L	22 mm	G 3/4"
6009-22-17	GE 22 L	22 mm	G 1"
6009-28-13	GE 28 L	28 mm	G 3/4"
6009-28-17	GE 28 L	28 mm	G 1"
6009-28-21	GE 28 L	28 mm	G 1 1/4"
6009-35-17	GE 35 L	35 mm	G 1"
6009-35-21	GE 35 L	35 mm	G 1 1/4"
6009-42-21	GE 42 L	42 mm	G 1 1/4"
6009-42-25	GE 42 L	42 mm	G 1 1/2"
6509-06-05	GE 6 S	6 mm	G 1/4"
6509-08-05	GE 8 S	8 mm	G 1/4"
6509-08-07	GE 8 S	8 mm	G 3/8"
6509-08-09	GE 8 S	8 mm	G 1/2"
6509-10-05	GE 10 S	10 mm	G 1/4"
6509-10-07	GE 10 S	10 mm	G 3/8"
6509-12-05	GE 12 S	12 mm	G 1/4"
6509-12-07	GE 12 S	12 mm	G 3/8"
6509-12-09	GE 12 S	12 mm	G 1/2"
6509-14-09	GE 14 S	14 mm	G 1/2"
6509-16-07	GE 16 S	16 mm	G 3/8"
6509-16-09	GE 16 S	16 mm	G 1/2"
6509-16-13	GE 16 S	16 mm	G 3/4"
6509-20-09	GE 20 S	20 mm	G 1/2"
6509-20-13	GE 20 S	20 mm	G 3/4"
6509-20-17	GE 20 S	20 mm	G 1"
6509-25-09	GE 25 S	25 mm	G 1/2"
6509-25-13	GE 25 S	25 mm	G 3/4"
6509-25-17	GE 25 S	25 mm	G 1"
6509-30-17	GE 30 S	30 mm	G 1"
6509-30-21	GE 30 S	30 mm	G 1 1/4"
6509-38-21	GE 38 S	38 mm	G 1 1/4"
6509-38-25	GE 38 S	38 mm	G 1 1/2"



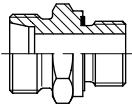

**6010/6510****GE-M/ED**

Straight fitting - G M  
Body  
ISO 9974-2  
PRODUCT GROUP 600

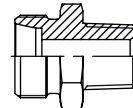
**6007/6507****GE-NPT**

Straight fitting - NPT M  
Body  
ANSI/ASME B1.20.1-1983  
PRODUCT GROUP 600

Part number	Type	Pipe size	Thread
6010-06-11	GE 6 L	6 mm	M 10 x 1.0
6010-08-13	GE 8 L	8 mm	M 12 x 1.5
6010-10-15	GE 10 L	10 mm	M 14 x 1.5
6010-10-17	GE 10 L	10 mm	M 16 x 1.5
6010-12-15	GE 12 L	12 mm	M 14 x 1.5
6010-12-17	GE 12 L	12 mm	M 16 x 1.5
6010-12-19	GE 12 L	12 mm	M 18 x 1.5
6010-12-23	GE 12 L	12 mm	M 22 x 1.5
6010-15-19	GE 15 L	15 mm	M 18 x 1.5
6010-15-23	GE 15 L	15 mm	M 22 x 1.5
6010-18-23	GE 18 L	18 mm	M 22 x 1.5
6010-22-27	GE 22 L	22 mm	M 26 x 1.5
6010-28-34	GE 28 L	28 mm	M 33 x 2.0
6010-35-43	GE 35 L	35 mm	M 42 x 2.0
6010-42-49	GE 42 L	42 mm	M 48 x 2.0
6510-06-13	GE 6 S	6 mm	M 12 x 1.5
6510-08-15	GE 8 S	8 mm	M 14 x 1.5
6510-10-17	GE 10 S	10 mm	M 16 x 1.5
6510-12-19	GE 12 S	12 mm	M 18 x 1.5
6510-14-21	GE 14 S	14 mm	M 20 x 1.5
6510-16-23	GE 16 S	16 mm	M 22 x 1.5
6510-20-23	GE 20 S	20 mm	M 22 x 1.5
6510-20-28	GE 20 S	20 mm	M 27 x 2.0
6510-25-34	GE 25 S	25 mm	M 33 x 2.0
6510-30-43	GE 30 S	30 mm	M 42 x 2.0
6510-38-49	GE 38 S	38 mm	M 48 x 2.0

Part number	Type	Pipe size	Thread
6007-06-03	GE 6 L	6 mm	1/8"-27 NPT
6007-06-05	GE 6 L	6 mm	1/4"-18 NPT
6007-06-07	GE 6 L	6 mm	3/8"-18 NPT
6007-08-03	GE 8 L	8 mm	1/8"-27 NPT
6007-08-05	GE 8 L	8 mm	1/4"-18 NPT
6007-10-05	GE 10 L	10 mm	1/4"-18 NPT
6007-10-07	GE 10 L	10 mm	3/8"-18 NPT
6007-12-05	GE 12 L	12 mm	1/4"-18 NPT
6007-12-07	GE 12 L	12 mm	3/8"-18 NPT
6007-12-09	GE 12 L	12 mm	1/2"-14 NPT
6007-15-07	GE 15 L	15 mm	3/8" 18 NPT
6007-15-09	GE 15 L	15 mm	1/2"-14 NPT
6007-15-13	GE 15 L	15 mm	3/4"-14 NPT
6007-18-09	GE 18 L	18 mm	1/2"-14 NPT
6007-22-09	GE 22 L	22 mm	1/2"-14 NPT
6007-22-13	GE 22 L	22 mm	3/4"-14 NPT
6007-28-17	GE 28 L	28 mm	1"-11½ NPT
6007-35-21	GE 35 L	35 mm	1 1/4"-11½ NPT
6007-42-25	GE 42 L	42 mm	1 1/2"-11½ NPT
6507-06-05	GE 6 S	6 mm	1/4"-18 NPT
6507-08-05	GE 8 S	8 mm	1/4"-18 NPT
6507-10-05	GE 10 S	10 mm	1/4"-18 NPT
6507-10-07	GE 10 S	10 mm	3/8"-18 NPT
6507-12-05	GE 12 S	12 mm	1/4"-18 NPT
6507-12-07	GE 12 S	12 mm	3/8"-18 NPT
6507-12-09	GE 12 S	12 mm	1/2"-14 NPT
6507-12-13	GE 12 S	12 mm	3/4" 14 NPT
6507-14-09	GE 14 S	14 mm	1/2"-14 NPT
6507-16-09	GE 16 S	16 mm	1/2"-14 NPT
6507-20-09	GE 20 S	20 mm	1/2"-14 NPT
6507-20-13	GE 20 S	20 mm	3/4"-14 NPT
6507-25-17	GE 25 S	25 mm	1"-11½ NPT
6507-30-21	GE 30 S	30 mm	1 1/4"-11½ NPT
6507-38-25	GE 38 S	38 mm	1 1/2"-11½ NPT

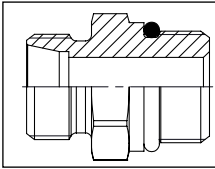

**6008/6508**

**GE – UNF**  
 Straight fitting – UNF M  
 Body  
 UN-UNF SAE J514  
**PRODUCT GROUP 600**

Part number	Type	Pipe size	Thread
6008-06-08	GE 6 L	6 mm	7/16"-20 UNF
6008-08-08	GE 8 L	8 mm	7/16"-20 UNF
6008-08-09	GE 8 L	8 mm	1/2"-20 UNF
6008-10-08	GE 10 L	10 mm	7/16"-20 UNF
6008-10-10	GE 10 L	10 mm	9/16"-18 UNF
6008-12-10	GE 12 L	12 mm	9/16"-18 UNF
6008-12-13	GE 12 L	12 mm	3/4"-16 UNF
6008-12-15	GE 12 L	12 mm	7/8"-14 UNF
6008-15-13	GE 15 L	15 mm	3/4"-16 UNF
6008-15-15	GE 15 L	15 mm	7/8"-14 UNF
6008-18-13	GE 18 L	18 mm	3/4"-16 UNF
6008-18-15	GE 18 L	18 mm	7/8"-14 UNF
6008-22-15	GE 22 L	22 mm	7/8"-14 UNF
6008-22-18	GE 22 L	22 mm	1 1/16"-12 UN
6008-22-22	GE 22 L	22 mm	1 5/16"-12 UN
6008-28-18	GE 28 L	28 mm	1 1/16"-12 UN
6008-28-22	GE 28 L	28 mm	1 5/16"-12 UN
6008-35-22	GE 35 L	35 mm	1 5/16"-12 UN
6008-35-27	GE 35 L	35 mm	1 5/8"-12 UN
6008-42-27	GE 42 L	42 mm	1 5/8"-12 UN
6008-42-31	GE 42 L	42 mm	1 7/8"-12 UN
6508-08-08	GE 8 S	8 mm	7/16"-20 UNF
6508-08-09	GE 8 S	8 mm	1/2"-20 UNF
6508-10-10	GE 10 S	10 mm	9/16"-18 UNF
6508-12-10	GE 12 S	12 mm	9/16"-18 UNF
6508-12-13	GE 12 S	12 mm	3/4"-16 UNF
6508-16-13	GE 16 S	16 mm	3/4"-16 UNF
6508-16-15	GE 16 S	16 mm	7/8"-14 UNF
6508-20-13	GE 20 S	20 mm	3/4"-16 UNF
6508-20-15	GE 20 S	20 mm	7/8"-14 UNF
6508-20-18	GE 20 S	20 mm	1 1/16"-12 UN
6508-25-18	GE 25 S	25 mm	1 1/16"-12 UN
6508-25-22	GE 25 S	25 mm	1 5/16"-12 UN
6508-30-22	GE 30 S	30 mm	1 5/16"-12 UN
6508-38-27	GE 38 S	38 mm	1 5/8"-12 UN
6508-38-31	GE 38 S	38 mm	1 7/8"-12 UN

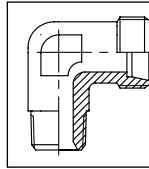

**6011/6511**

**WE-R/C**  
 90° elbow fitting – R M  
 Body  
 C DIN 3852  
**PRODUCT GROUP 600**

Part number	Type	Pipe size	Thread
6011-06-03	WE 6 L	6 mm	R 1/8"
6011-06-05	WE 6 L	6 mm	R 1/4"
6011-08-03	WE 8 L	8 mm	R 1/8"
6011-08-05	WE 8 L	8 mm	R 1/4"
6011-08-07	WE 8 L	8 mm	R 3/8"
6011-10-05	WE 10 L	10 mm	R 1/4"
6011-10-07	WE 10 L	10 mm	R 3/8"
6011-12-05	WE 12 L	12 mm	R 1/4"
6011-12-07	WE 12 L	12 mm	R 3/8"
6011-12-09	WE 12 L	12 mm	R 1/2"
6011-15-07	WE 15 L	15 mm	R 3/8"
6011-15-09	WE 15 L	15 mm	R 1/2"
6011-18-09	WE 18 L	18 mm	R 1/2"
6011-18-13	WE 18 L	18 mm	R 3/4"
6011-22-13	WE 22 L	20 mm	R 3/4"
6511-06-05	WE 6 S	6 mm	R 1/4"
6511-08-05	WE 8 S	8 mm	R 1/4"
6511-10-07	WE 10 S	10 mm	R 3/8"
6511-12-07	WE 12 S	12 mm	R 3/8"
6511-14-07	WE 14 S	14 mm	R 3/8"
6511-14-09	WE 14 S	14 mm	R 1/2"
6511-16-09	WE 16 S	16 mm	R 1/2"
6511-20-13	WE 20 S	20 mm	R 3/4"

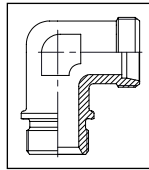

**6013/6513**

**WE-GB**  
 90° elbow fitting – G M  
 Body  
**PRODUCT GROUP 600**  
 B DIN 3852

Part number	Type	Pipe size	Thread
6013-22-13	WE 22 L	22 mm	G 3/4"
6013-28-17	WE 28 L	28 mm	G 1"
6513-20-13	WE 20 S	20 mm	G 3/4"

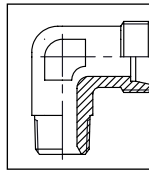

**6014/6514**

**WE-MKC**  
 90° elbow fitting – MK M  
 Body  
**PRODUCT GROUP 600**  
 C DIN 3852

Part number	Type	Pipe size	Thread
6014-06-11	WE 6 L	6 mm	M 10 x 1,0 K
6014-08-13	WE 8 L	8 mm	M 12 x 1,5 K
6014-10-15	WE 10 L	10 mm	M 14 x 1,5 K
6014-12-17	WE 12 L	12 mm	M 16 x 1,5 K
6014-15-19	WE 15 L	15 mm	M 18 x 1,5 K
6014-18-23	WE 18 L	18 mm	M 22 x 1,5 K
6514-06-13	WE 6 S	6 mm	M 12 x 1,5 K
6514-08-15	WE 8 S	8 mm	M 14 x 1,5 K
6514-10-17	WE 10 S	10 mm	M 16 x 1,5 K
6514-12-19	WE 12 S	12 mm	M 18 x 1,5 K
6514-14-21	WE 14 S	14 mm	M 20 x 1,5 K
6514-16-23	WE 16 S	16 mm	M 22 x 1,5 K



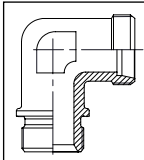

**6016/6516**

**WE – MB**  
90° elbow fitting – M M  
Body  
B DIN 3852  
PRODUCT GROUP 600

Part number	Type	Pipe size	Thread
6016-22-27	WE 22 L	22 mm	M 26 x 1,5
6016-28-34	WE 28 L	28 mm	M 33 x 2,0
6016-35-43	WE 35 L	35 mm	M 42 x 2,0
6016-42-49	WE 42 L	42 mm	M 48 x 2,0
6516-20-28	WE 20 S	20 mm	M 27 x 1,5
6516-25-34	WE 25 S	25 mm	M 33 x 2,0
6516-30-43	WE 30 S	30 mm	M 42 x 2,0
6516-38-49	WE 38 S	38 mm	M 48 x 2,0

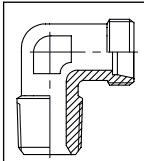

**6017/6517**

**WE – NPT**  
90° elbow fitting NPT M  
Body  
ANSI/ASME B1.20.1-1983  
PRODUCT GROUP 600

Part number	Type	Pipe size	Thread
6017-06-03	WE 6 L	6 mm	1/8"-27 NPT
6017-06-05	WE 6 L	6 mm	1/4"-18 NPT
6017-08-05	WE 8 L	8 mm	1/4"-18 NPT
6017-10-05	WE 10 L	10 mm	1/4"-18 NPT
6017-12-07	WE 12 L	12 mm	3/8"-18 NPT
6017-15-09	WE 15 L	15 mm	1/2"-14 NPT
6017-18-09	WE 18 L	18 mm	1/2"-14 NPT
6017-22-13	WE 22 L	22 mm	3/4"-14 NPT
6017-28-17	WE 28 L	28 mm	1"-11 1/2 NPT
6017-35-21	WE 35 L	35 mm	1 1/4"-11 1/2 NPT
6017-42-25	WE 42 L	42 mm	1 1/2"-11 1/2 NPT
6517-06-05	WE 6 S	6 mm	1/4"-18 NPT
6517-08-05	WE 8 S	8 mm	1/4"-18 NPT
6517-10-07	WE 10 S	10 mm	3/8"-18 NPT
6517-12-07	WE 12 S	12 mm	3/8"-18 NPT
6517-14-09	WE 14 S	14 mm	1/2"-14 NPT
6517-16-09	WE 16 S	16 mm	1/2"-14 NPT
6517-20-13	WE 20 S	20 mm	3/4"-14 NPT
6517-25-17	WE 25 S	25 mm	1"-11 1/2 NPT
6517-30-21	WE 30 S	30 mm	1 1/4"-11 1/2 NPT

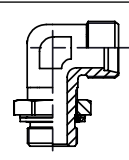

**6012/6512**

**WEE – G**  
Adjustable 90° elbow fitting – G M  
Body  
B DIN 3852  
PRODUCT GROUP 600

Part number	Type	Pipe size	Thread
6012-06-03	WEE 6 L	6 mm	G 1/8"
6012-08-05	WEE 8 L	8 mm	G 1/4"
6012-10-05	WEE 10 L	10 mm	G 1/4"
6012-12-07	WEE 12 L	12 mm	G 3/8"
6012-15-09	WEE 15 L	15 mm	G 1/2"
6012-18-09	WEE 18 L	18 mm	G 1/2"
6012-22-13	WEE 22 L	22 mm	G 3/4"
6012-28-17	WEE 28 L	28 mm	G 1"
6012-35-21	WEE 35 L	35 mm	G 1 1/4"
6012-42-25	WEE 42 L	42 mm	G 1 1/2"
6512-06-05	WEE 6 S	6 mm	G 1/4"
6512-08-05	WEE 8 S	8 mm	G 1/4"
6512-10-07	WEE 10 S	10 mm	G 3/8"
6512-12-07	WEE 12 S	12 mm	G 3/8"
6512-14-09	WEE 14 S	14 mm	G 1/2"
6512-16-09	WEE 16 S	16 mm	G 1/2"
6512-20-13	WEE 20 S	20 mm	G 3/4"
6512-25-17	WEE 25 S	25 mm	G 1"
6512-30-21	WEE 30 S	30 mm	G 1 1/4"
6512-38-25	WEE 38 S	38 mm	G 1 1/2"

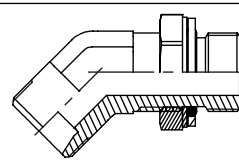

**6018/6518**

**VEE – G**  
Adjustable 45° elbow fitting – G M  
O-ring with washer  
ISO 1174-3  
PRODUCT GROUP 600

Part number	Type	Pipe size	Thread
6018-06-03	VEE 6 L	6 mm	G 1/8"
6018-08-05	VEE 8 L	8 mm	G 1/4"
6018-10-05	VEE 10 L	10 mm	G 1/4"
6018-12-07	VEE 12 L	12 mm	G 3/8"
6018-15-09	VEE 15 L	15 mm	G 1/2"
6018-18-09	VEE 18 L	18 mm	G 1/2"
6018-22-13	VEE 22 L	22 mm	G 3/4"
6018-28-17	VEE 28 L	28 mm	G 1"
6018-35-21	VEE 35 L	35 mm	G 1 1/4"
6018-42-25	VEE 42 L	42 mm	G 1 1/2"
6518-06-05	VEE 6 S	6 mm	G 1/4"
6518-08-05	VEE 8 S	8 mm	G 1/4"
6518-10-07	VEE 10 S	10 mm	G 3/8"
6518-12-07	VEE 12 S	12 mm	G 3/8"
6518-14-09	VEE 14 S	14 mm	G 1/2"
6518-16-09	VEE 16 S	16 mm	G 1/2"
6518-20-13	VEE 20 S	20 mm	G 3/4"
6518-25-17	VEE 25 S	25 mm	G 1"
6518-30-21	VEE 30 S	30 mm	G 1 1/4"
6518-38-25	VEE 38 S	38 mm	G 1 1/2"

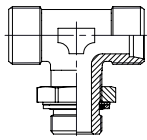

**6022/6522**

**TEE – GB**  
Adjustable T-fitting – G M  
Body  
DIN 2353  
PRODUCT GROUP 600

Part number	Type	Pipe size	Thread
6022-06-03	TEE 6 L	6 mm	G 1/8"
6022-08-05	TEE 8 L	8 mm	G 1/4"
6022-10-05	TEE 10 L	10 mm	G 1/4"
6022-12-07	TEE 12 L	12 mm	G 3/8"
6022-15-09	TEE 15 L	15 mm	G 1/2"
6022-18-09	TEE 18 L	18 mm	G 1/2"
6022-22-13	TEE 22 L	22 mm	G 3/4"
6022-28-17	TEE 28 L	28 mm	G 1"
6022-35-21	TEE 35 L	35 mm	G 1 1/4"
6022-42-25	TEE 42 L	42 mm	G 1 1/2"
6522-06-05	TEE 6 S	6 mm	G 1/4"
6522-08-05	TEE 8 S	8 mm	G 1/4"
6522-10-07	TEE 10 S	10 mm	G 3/8"
6522-12-07	TEE 12 S	12 mm	G 3/8"
6522-14-09	TEE 14 S	14 mm	G 1/2"
6522-16-09	TEE 16 S	16 mm	G 1/2"
6522-20-13	TEE 20 S	20 mm	G 3/4"
6522-25-17	TEE 25 S	25 mm	G 1"
6522-30-21	TEE 30 S	30 mm	G 1 1/4"
6522-38-25	TEE 38 S	38 mm	G 1 1/2"

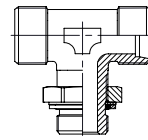

**6025/6525**

**TEE – M**  
Adjustable T-fitting – M M  
Body  
PRODUCT GROUP 600  
DIN 2353

Part number	Type	Pipe size	Thread
6025-06-11	TEE 6 L	6 mm	M 10 x 1,0
6025-08-13	TEE 8 L	8 mm	M 12 x 1,5
6025-10-15	TEE 10 L	10 mm	M 14 x 1,5
6025-12-17	TEE 12 L	12 mm	M 16 x 1,5
6025-15-19	TEE 15 L	15 mm	M 18 x 1,5
6025-18-23	TEE 18 L	18 mm	M 22 x 1,5
6025-22-28	TEE 22 L	22 mm	M 27 x 2,0
6025-28-34	TEE 28 L	28 mm	M 33 x 2,0
6025-35-43	TEE 35 L	35 mm	M 42 x 2,0
6025-42-49	TEE 42 L	42 mm	M 48 x 2,0
6525-06-13	TEE 6 S	6 mm	M 12 x 1,5
6525-08-15	TEE 8 S	8 mm	M 14 x 1,5
6525-10-17	TEE 10 S	10 mm	M 16 x 1,5
6525-12-19	TEE 12 S	12 mm	M 18 x 1,5
6525-14-21	TEE 14 S	14 mm	M 20 x 1,5
6525-16-23	TEE 16 S	16 mm	M 22 x 1,5
6525-20-28	TEE 20 S	20 mm	M 27 x 2,0
6525-25-34	TEE 25 S	25 mm	M 33 x 2,0
6525-30-43	TEE 30 S	30 mm	M 42 x 2,0
6525-38-49	TEE 38 S	38 mm	M 48 x 2,0

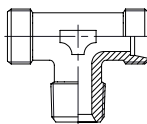

**6021/6521**

**TE-R/C**  
T-fitting – R M  
Body  
C DIN 3852  
PRODUCT GROUP 600

Part number	Type	Pipe size	Thread
6021-06-03	TE 6 L	6 mm	R 1/8"
6021-08-05	TE 8 L	8 mm	R 1/4"
6021-10-05	TE 10 L	10 mm	R 1/4"
6021-12-07	TE 12 L	12 mm	R 3/8"
6021-15-09	TE 15 L	15 mm	R 1/2"
6021-18-09	TE 18 L	18 mm	R 1/2"
6521-06-05	TE 6 S	6 mm	R 1/4"
6521-08-05	TE 8 S	8 mm	R 1/4"
6521-10-07	TE 10 S	10 mm	R 3/8"
6521-12-07	TE 12 S	12 mm	R 3/8"
6521-14-09	TE 14 S	14 mm	R 1/2"
6521-16-09	TE 16 S	16 mm	R 1/2"

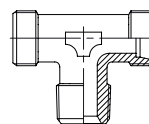

**6024**

**TE – M**  
T-fitting – MK M  
Body  
PRODUCT GROUP 600  
C DIN 3852

Part number	Type	Pipe size	Thread
6024-08-13	TE 8 L	8 mm	M 12 x 1,5 K
6024-10-15	TE 10 L	10 mm	M 14 x 1,5 K
6024-12-17	TE 12 L	12 mm	M 16 x 1,5 K
6024-15-19	TE 15 L	15 mm	M 18 x 1,5 K
6024-18-23	TE 18 L	18 mm	M 22 x 1,5 K

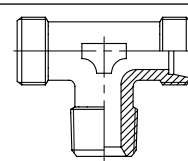

**6027**

**TE – NPT**  
T-fitting – NPT M  
Body  
ANSI/ASME B1.20.1-1983  
PRODUCT GROUP 600

Part number	Type	Pipe size	Thread
6027-06-03	TE 6 L	6 mm	NPT 1/8"
6027-10-05	TE 10 L	10 mm	NPT 1/4"
6027-12-07	TE 12 L	12 mm	NPT 3/8"
6027-22-13	TE 22 L	22 mm	NPT 3/4"

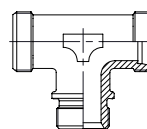

**6023/6523**

**TE-GB**  
T-fitting – G M  
Body  
B DIN 3852  
PRODUCT GROUP 600

Part number	Type	Pipe size	Thread
6023-22-13	TE 22 L	22 mm	G 3/4"
6023-28-17	TE 28 L	28 mm	G 1"
6023-35-21	TE 35 L	35 mm	G 1 1/4"
6023-42-25	TE 42 L	42 mm	G 1 1/2"
6523-20-13	TE 20 S	20 mm	G 3/4"
6523-25-17	TE 25 S	25 mm	G 1"
6523-30-21	TE 30 S	30 mm	G 1 1/4"
6523-38-25	TE 38 S	38 mm	G 1 1/2"



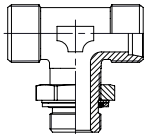

**6026/6526**  
**TEE – UNF**  
 T-fitting – UNF M  
 Body  
 DIN 2353  
**PRODUCT GROUP 600**

Part number	Type	Pipe size	Thread
6026-06-08	TEE 6 L	6 mm	7/16-20" UNF
6026-08-08	TEE 8 L	8 mm	7/16-20" UNF
6026-10-10	TEE 10 L	10 mm	9/16-18" UNF
6026-12-13	TEE 12 L	12 mm	3/4-16" UNF
6026-15-15	TEE 15 L	15 mm	7/8-14" UNF
6026-18-15	TEE 18 L	18 mm	7/8-14" UNF
6026-22-18	TEE 22 L	22 mm	11/16-12" UN
6026-28-22	TEE 28 L	28 mm	15/16-12" UN
6026-35-27	TEE 35 L	35 mm	15/8-12" UN
6026-42-31	TEE 42 L	42 mm	17/8-12" UN
6526-06-08	TEE 6 S	6 mm	7/16-20" UNF
6526-08-10	TEE 8 S	8 mm	9/16-18" UNF
6526-10-10	TEE 10 S	10 mm	9/16-18" UNF
6526-12-13	TEE 12 S	12 mm	3/4-16" UNF
6526-14-15	TEE 14 S	14 mm	7/8-14" UNF
6526-16-15	TEE 16 S	16 mm	7/8-14" UNF
6526-20-18	TEE 20 S	20 mm	11/16-12" UN
6526-25-22	TEE 25 S	25 mm	15/16-12" UN
6526-30-27	TEE 30 S	30 mm	15/8-12" UN
6526-38-31	TEE 38 S	38 mm	17/8-12" UN



**6029/6529**  
**LEE – G**  
 Adjustable L-fitting – G M  
 Body  
 DIN 2353  
**PRODUCT GROUP 600**

Part number	Type	Pipe size	Thread
6029-06-03	LEE 6 L	6 mm	G 1/8"
6029-08-05	LEE 8 L	8 mm	G 1/4"
6029-10-05	LEE 10 L	10 mm	G 1/4"
6029-12-07	LEE 12 L	12 mm	G 3/8"
6029-15-09	LEE 15 L	15 mm	G 1/2"
6029-18-09	LEE 18 L	18 mm	G 1/2"
6029-22-13	LEE 22 L	22 mm	G 3/4"
6029-28-17	LEE 28 L	28 mm	G 1"
6029-35-21	LEE 35 L	35 mm	G 1 1/4"
6029-42-25	LEE 42 L	42 mm	G 1 1/2"
6529-06-05	LEE 6 S	6 mm	G 1/4"
6529-08-05	LEE 8 S	8 mm	G 1/4"
6529-10-07	LEE 10 S	10 mm	G 3/8"
6529-12-07	LEE 12 S	12 mm	G 3/8"
6529-14-09	LEE 14 S	14 mm	G 1/2"
6529-16-09	LEE 16 S	16 mm	G 1/2"
6529-20-13	LEE 20 S	20 mm	G 3/4"
6529-25-17	LEE 25 S	25 mm	G 1"
6529-30-21	LEE 30 S	30 mm	G 1 1/4"
6529-38-25	LEE 38 S	38 mm	G 1 1/2"



**6031/6531**  
**LE – R/C**  
 L-fitting – R M  
 Body  
 C DIN 3852  
**PRODUCT GROUP 600**

Part number	Type	Pipe size	Thread
6031-06-03	LE 6 L	6 mm	R 1/8"
6031-08-05	LE 8 L	8 mm	R 1/4"
6031-10-05	LE 10 L	10 mm	R 1/4"
6031-12-07	LE 12 L	12 mm	R 3/8"
6031-15-09	LE 15 L	15 mm	R 1/2"
6031-18-09	LE 18 L	18 mm	R 1/2"
6531-06-05	LE 6 S	6 mm	R 1/4"
6531-08-05	LE 8 S	8 mm	R 1/4"
6531-10-07	LE 10 S	10 mm	R 3/8"
6531-12-07	LE 12 S	12 mm	R 3/8"
6531-14-09	LE 14 S	14 mm	R 1/2"
6531-16-09	LE 16 S	16 mm	R 1/2"



**6033/6533**  
**LE – GB**  
 L-fitting – G M  
 Body  
 B DIN 3852  
**PRODUCT GROUP 600**

Part number	Type	Pipe size	Thread
6033-22-13	LE 22 L	22 mm	G 3/4"
6033-28-17	LE 28 L	28 mm	G 1"
6033-35-21	LE 35 L	35 mm	G 1 1/4"
6033-42-25	LE 42 L	42 mm	G 1 1/2"
6533-20-13	LE 20 S	20 mm	G 3/4"
6533-25-17	LE 25 S	25 mm	G 1"
6533-30-21	LE 30 S	30 mm	G 1 1/4"
6533-38-25	LE 38 S	38 mm	G 1 1/2"



**6036**  
**LE – MB**  
 L-fitting – M M  
 Body  
 B DIN 3852  
**PRODUCT GROUP 600**

Part number	Type	Pipe size	Thread
6036-22-27	LE 22 L	22 mm	M 26 x 1,5
6036-28-34	LE 28 L	28 mm	M 33 x 2,0
6036-35-43	LE 35 L	35 mm	M 42 x 2,0
6036-42-49	LE 42 L	42 mm	M 48 x 2,0



Part number	Type	Pipe size	Thread
6030-06-11	LEE 6 L	6 mm	M 10 x 1,0
6030-08-13	LEE 8 L	8 mm	M 12 x 1,5
6030-10-15	LEE 10 L	10 mm	M 14 x 1,5
6030-12-17	LEE 12 L	12 mm	M 16 x 1,5
6030-15-19	LEE 15 L	15 mm	M 18 x 1,5
6030-18-23	LEE 18 L	18 mm	M 22 x 1,5
6030-22-28	LEE 22 L	22 mm	M 27 x 2,0
6030-28-34	LEE 28 L	28 mm	M 33 x 2,0
6030-35-43	LEE 35 L	35 mm	M 42 x 2,0
6030-42-49	LEE 42 L	42 mm	M 48 x 2,0
6530-06-13	LEE 6 S	6 mm	M 12 x 1,5
6530-08-15	LEE 8 S	8 mm	M 14 x 1,5
6530-10-17	LEE 10 S	10 mm	M 16 x 1,5
6530-12-19	LEE 12 S	12 mm	M 18 x 1,5
6530-14-21	LEE 14 S	14 mm	M 20 x 1,5
6530-16-23	LEE 16 S	16 mm	M 22 x 1,5
6530-20-28	LEE 20 S	20 mm	M 27 x 2,0
6530-25-34	LEE 25 S	25 mm	M 33 x 2,0
6530-30-43	LEE 30 S	30 mm	M 42 x 2,0
6530-38-49	LEE 38 S	38 mm	M 48 x 2,0

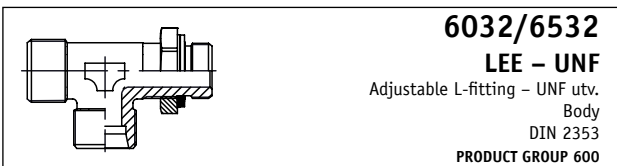

Part number	Type	Pipe size	Thread
6032-06-08	LEE 6 L	6 mm	7/16-20" UNF
6032-08-08	LEE 8 L	8 mm	7/16-20" UNF
6032-10-10	LEE 10 L	10 mm	9/16-18" UNF
6032-12-13	LEE 12 L	12 mm	3/4-16" UNF
6032-15-15	LEE 15 L	15 mm	7/8-14" UNF
6032-18-15	LEE 18 L	18 mm	7/8-14" UNF
6032-22-18	LEE 22 L	22 mm	11/16-12" UN
6032-28-22	LEE 28 L	28 mm	15/16-12" UN
6032-35-27	LEE 35 L	35 mm	15/8-12" UN
6032-42-31	LEE 42 L	42 mm	17/8-12" UN
6532-06-08	LEE 6 S	6 mm	7/16-20" UNF
6532-08-10	LEE 8 S	8 mm	9/16-18" UNF
6532-10-10	LEE 10 S	10 mm	9/16-18" UNF
6532-12-13	LEE 12 S	12 mm	3/4-16" UNF
6532-14-15	LEE 14 S	14 mm	7/8-14" UNF
6532-16-15	LEE 16 S	16 mm	7/8-14" UNF
6532-20-18	LEE 20 S	20 mm	11/16-12" UN
6532-25-22	LEE 25 S	25 mm	15/16-12" UN
6532-30-27	LEE 30 S	30 mm	15/8-12" UN
6532-38-31	LEE 38 S	38 mm	17/8-12" UN

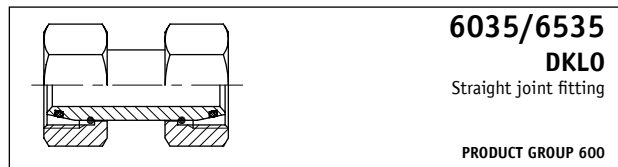

Part number	Type	Pipe size
6035-06-06	DKLO 6 x DKLO 6	6 mm
6035-08-08	DKLO 8 x DKLO 8	8 mm
6035-10-10	DKLO 10 x DKLO 10	10 mm
6035-12-12	DKLO 12 x DKLO 12	12 mm
6035-15-15	DKLO 15 x DKLO 15	15 mm
6035-18-18	DKLO 18 x DKLO 18	18 mm
6035-22-22	DKLO 22 x DKLO 22	22 mm
6035-28-28	DKLO 28 x DKLO 28	28 mm
6035-35-35	DKLO 35 x DKLO 35	35 mm
6035-42-42	DKLO 42 x DKLO 42	42 mm
6535-06-06	DKSO 6 x DKSO 6	6 mm
6535-08-08	DKSO 8 x DKSO 8	8 mm
6535-10-10	DKSO 10 x DKSO 10	10 mm
6535-12-12	DKSO 12 x DKSO 12	12 mm
6535-14-14	DKSO 14 x DKSO 14	14 mm
6535-16-16	DKSO 16 x DKSO 16	16 mm
6535-20-20	DKSO 20 x DKSO 20	20 mm
6535-25-25	DKSO 25 x DKSO 25	25 mm
6535-30-30	DKSO 30 x DKSO 30	30 mm
6535-30-38	DKSO 30 x DKSO 38	30 mm
6535-38-38	DKSO 38 x DKSO 38	38 mm

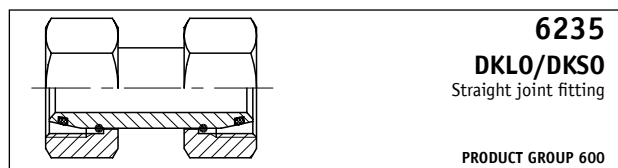

Part number	Type	Pipe size
6235-10-12	DKLO 10 x DKSO 12	10 mm-12 mm
6235-10-14	DKLO 10 x DKSO 14	10 mm-14 mm
6235-12-14	DKLO 12 x DKSO 14	12 mm-14 mm
6235-12-16	DKLO 12 x DKSO 16	12 mm-16 mm
6235-15-16	DKLO 15 x DKSO 16	15 mm-16 mm
6235-15-20	DKLO 15 x DKSO 20	15 mm-20 mm
6235-18-20	DKLO 18 x DKSO 20	18 mm-20 mm
6235-18-25	DKLO 18 x DKSO 25	18 mm-25 mm
6235-28-25	DKLO 28 x DKSO 25	28 mm-25 mm

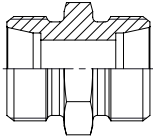

**6041/6541**

**G**  
Straight joint fitting  
Body

PRODUCT GROUP 600

Part number	Type	Pipe size
6041-06-07	G 6 L	6 mm
6041-08-09	G 8 L	8 mm
6041-10-11	G 10 L	10 mm
6041-12-13	G 12 L	12 mm
6041-15-16	G 15 L	15 mm
6041-18-19	G 18 L	18 mm
6041-22-23	G 22 L	22 mm
6041-28-29	G 28 L	28 mm
6041-35-36	G 35 L	35 mm
6041-42-43	G 42 L	42 mm
6541-06-07	G 6 S	6 mm
6541-08-09	G 8 S	8 mm
6541-10-11	G 10 S	10 mm
6541-12-13	G 12 S	12 mm
6541-14-15	G 14 S	14 mm
6541-16-17	G 16 S	16 mm
6541-20-21	G 20 S	20 mm
6541-25-26	G 25 S	25 mm
6541-30-31	G 30 S	30 mm
6541-38-39	G 38 S	38 mm

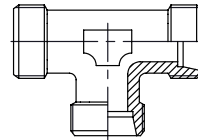
**6043/6543**

**T**  
T-joint fitting  
Body

PRODUCT GROUP 600

Part number	Type	Pipe size
6043-06-07	T 6 L	6 mm
6043-08-09	T 8 L	8 mm
6043-10-11	T 10 L	10 mm
6043-12-13	T 12 L	12 mm
6043-15-16	T 15 L	15 mm
6043-18-19	T 18 L	18 mm
6043-22-23	T 22 L	22 mm
6043-28-29	T 28 L	28 mm
6043-35-36	T 35 L	35 mm
6043-42-43	T 42 L	42 mm
6543-06-07	T 6 S	6 mm
6543-08-09	T 8 S	8 mm
6543-10-11	T 10 S	10 mm
6543-12-13	T 12 S	12 mm
6543-14-15	T 14 S	14 mm
6543-16-17	T 16 S	16 mm
6543-20-21	T 20 S	20 mm
6543-25-26	T 25 S	25 mm
6543-30-31	T 30 S	30 mm
6543-38-39	T 38 S	38 mm

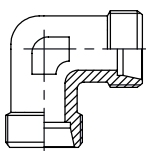
**6042/6542**

**W**  
Elbow joint fitting  
Body

PRODUCT GROUP 600

Part number	Type	Pipe size
6042-06-07	W 6 L	6 mm
6042-08-09	W 8 L	8 mm
6042-10-11	W 10 L	10 mm
6042-12-13	W 12 L	12 mm
6042-15-16	W 15 L	15 mm
6042-18-19	W 18 L	18 mm
6042-22-23	W 22 L	22 mm
6042-28-29	W 28 L	28 mm
6042-35-36	W 35 L	35 mm
6042-42-43	W 42 L	42 mm
6542-06-07	W 6 S	6 mm
6542-08-09	W 8 S	8 mm
6542-10-11	W 10 S	10 mm
6542-12-13	W 12 S	12 mm
6542-14-15	W 14 S	14 mm
6542-16-17	W 16 S	16 mm
6542-20-21	W 20 S	20 mm
6542-25-26	W 25 S	25 mm
6542-30-31	W 30 S	30 mm
6542-38-39	W 38 S	38 mm

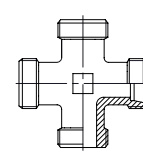
**6044/6544**

**K**  
Cross joint fitting  
Body

PRODUCT GROUP 600

Part number	Type	Pipe size
6044-06-07	K 6 L	6 mm
6044-08-09	K 8 L	8 mm
6044-10-11	K 10 L	10 mm
6044-12-13	K 12 L	12 mm
6044-15-16	K 15 L	15 mm
6044-18-19	K 18 L	18 mm
6044-22-23	K 22 L	22 mm
6044-28-29	K 28 L	28 mm
6044-35-36	K 35 L	35 mm
6044-42-43	K 42 L	42 mm
6544-06-07	K 6 S	6 mm
6544-08-09	K 8 S	8 mm
6544-10-11	K 10 S	10 mm
6544-12-13	K 12 S	12 mm
6544-14-15	K 14 S	14 mm
6544-16-17	K 16 S	16 mm
6544-20-21	K 20 S	20 mm
6544-25-26	K 25 S	25 mm
6544-30-31	K 30 S	30 mm
6544-38-39	K 38 S	38 mm

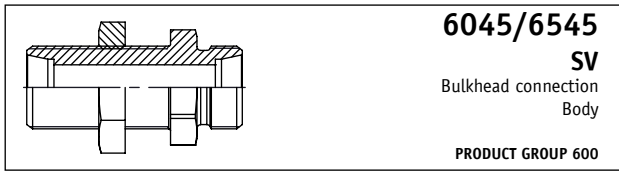

**6045/6545**

**SV**  
Bulkhead connection  
Body

PRODUCT GROUP 600

Part number	Type	Pipe size
6045-06-07	SV 6 L	6 mm
6045-08-09	SV 8 L	8 mm
6045-10-11	SV 10 L	10 mm
6045-12-13	SV 12 L	12 mm
6045-15-16	SV 15 L	15 mm
6045-18-19	SV 18 L	18 mm
6045-22-23	SV 22 L	22 mm
6045-28-29	SV 28 L	28 mm
6045-35-36	SV 35 L	35 mm
6045-42-43	SV 42 L	42 mm
6545-06-07	SV 6 S	6 mm
6545-08-09	SV 8 S	8 mm
6545-10-11	SV 10 S	10 mm
6545-12-13	SV 12 S	12 mm
6545-14-15	SV 14 S	14 mm
6545-16-17	SV 16 S	16 mm
6545-20-21	SV 20 S	20 mm
6545-25-26	SV 25 S	25 mm
6545-30-31	SV 30 S	30 mm
6545-38-39	SV 38 S	38 mm



**6047/6547**

**AS**  
Straight welding  
boss  
Body

PRODUCT GROUP 600

Part number	Type	Pipe size
6047-06-07	AS 6 L	6 mm
6047-08-09	AS 8 L	8 mm
6047-10-11	AS 10 L	10 mm
6047-12-13	AS 12 L	12 mm
6047-15-16	AS 15 L	15 mm
6047-18-19	AS 18 L	18 mm
6047-22-23	AS 22 L	22 mm
6047-28-29	AS 28 L	28 mm
6047-35-36	AS 35 L	35 mm
6047-42-43	AS 42 L	42 mm
6547-06-07	AS 6 S	6 mm
6547-08-09	AS 8 S	8 mm
6547-10-11	AS 10 S	10 mm
6547-12-13	AS 12 S	12 mm
6547-14-15	AS 14 S	14 mm
6547-16-17	AS 16 S	16 mm
6547-20-21	AS 20 S	20 mm
6547-25-26	AS 25 S	25 mm
6547-30-31	AS 30 S	30 mm
6547-38-39	AS 38 S	38 mm



**6046/6546**

**WSV**  
Elbow bulkhead connection  
Body

PRODUCT GROUP 600

Part number	Type	Pipe size
6046-06-07	WSV 6 L	6 mm
6046-08-09	WSV 8 L	8 mm
6046-10-11	WSV 10 L	10 mm
6046-12-13	WSV 12 L	12 mm
6046-15-16	WSV 15 L	15 mm
6046-18-19	WSV 18 L	18 mm
6046-22-23	WSV 22 L	22 mm
6046-28-29	WSV 28 L	28 mm
6046-35-36	WSV 35 L	35 mm
6046-42-43	WSV 42 L	42 mm
6546-06-07	WSV 6 S	6 mm
6546-08-09	WSV 8 S	8 mm
6546-10-11	WSV 10 S	10 mm
6546-12-13	WSV 12 S	12 mm
6546-14-15	WSV 14 S	14 mm
6546-16-17	WSV 16 S	16 mm
6546-20-21	WSV 20 S	20 mm
6546-25-26	WSV 25 S	25 mm
6546-30-31	WSV 30 S	30 mm
6546-38-39	WSV 38 S	38 mm

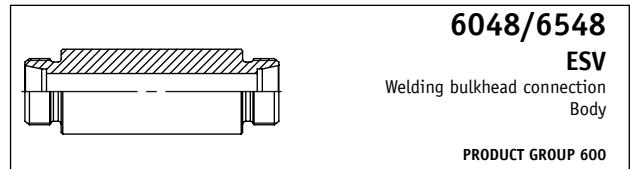

**6048/6548**

**ESV**  
Welding bulkhead connection  
Body

PRODUCT GROUP 600

Part number	Type	Pipe size
6048-06-07	ESV 6 L	6 mm
6048-08-09	ESV 8 L	8 mm
6048-10-11	ESV 10 L	10 mm
6048-12-13	ESV 12 L	12 mm
6048-15-16	ESV 15 L	15 mm
6048-18-19	ESV 18 L	18 mm
6048-22-23	ESV 22 L	22 mm
6048-28-29	ESV 28 L	28 mm
6048-35-36	ESV 35 L	35 mm
6048-42-43	ESV 42 L	42 mm
6548-06-07	ESV 6 S	6 mm
6548-08-09	ESV 8 S	8 mm
6548-10-11	ESV 10 S	10 mm
6548-12-13	ESV 12 S	12 mm
6548-14-15	ESV 14 S	14 mm
6548-16-17	ESV 16 S	16 mm
6548-20-21	ESV 20 S	20 mm
6548-25-26	ESV 25 S	25 mm
6548-30-31	ESV 30 S	30 mm
6548-38-39	ESV 38 S	38 mm







**6049/6549**  
**WAS**  
 Elbow welding fitting  
 Body  
**PRODUCT GROUP 600**

Part number	Type	Pipe size
6049-06-07	WAS 6 L	6 mm
6049-08-09	WAS 8 L	8 mm
6049-10-11	WAS 10 L	10 mm
6049-12-13	WAS 12 L	12 mm
6049-15-16	WAS 15 L	15 mm
6049-18-19	WAS 18 L	18 mm
6049-22-23	WAS 22 L	22 mm
6049-28-29	WAS 28 L	28 mm
6049-35-36	WAS 35 L	35 mm
6049-42-43	WAS 42 L	42 mm
6549-06-07	WAS 6 S	6 mm
6549-08-09	WAS 8 S	8 mm
6549-10-11	WAS 10 S	10 mm
6549-12-13	WAS 12 S	12 mm
6549-14-15	WAS 14 S	14 mm
6549-16-17	WAS 16 S	16 mm
6549-20-21	WAS 20 S	20 mm
6549-25-26	WAS 25 S	25 mm
6549-30-31	WAS 30 S	30 mm
6549-38-39	WAS 38 S	38 mm

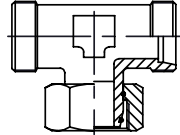

**6061/6561**  
**EVT-0**  
 Adjustable T-fitting with O-ring  
 Body  
**PRODUCT GROUP 600**

Part number	Type	Pipe size
6061-06-07	EVTO 6 L	6 mm
6061-08-09	EVTO 8 L	8 mm
6061-10-11	EVTO 10 L	10 mm
6061-12-13	EVTO 12 L	12 mm
6061-15-16	EVTO 15 L	15 mm
6061-18-19	EVTO 18 L	18 mm
6061-22-23	EVTO 22 L	22 mm
6061-28-29	EVTO 28 L	28 mm
6061-35-36	EVTO 35 L	35 mm
6061-42-43	EVTO 42 L	42 mm
6561-06-07	EVTO 6 S	6 mm
6561-08-09	EVTO 8 S	8 mm
6561-10-11	EVTO 10 S	10 mm
6561-12-13	EVTO 12 S	12 mm
6561-14-15	EVTO 14 S	14 mm
6561-16-17	EVTO 16 S	16 mm
6561-20-21	EVTO 20 S	20 mm
6561-25-26	EVTO 25 S	25 mm
6561-30-31	EVTO 30 S	30 mm
6561-38-39	EVTO 38 S	38 mm

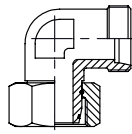

**6051/6551**  
**EVW-0**  
 Adjustable elbow fitting with O-ring  
 Body  
**PRODUCT GROUP 600**

Part number	Type	Pipe size
6051-06-07	EVWO 6 L	6 mm
6051-08-09	EVWO 8 L	8 mm
6051-10-11	EVWO 10 L	10 mm
6051-12-13	EVWO 12 L	12 mm
6051-15-16	EVWO 15 L	15 mm
6051-18-19	EVWO 18 L	18 mm
6051-22-23	EVWO 22 L	22 mm
6051-28-29	EVWO 28 L	28 mm
6051-35-36	EVWO 35 L	35 mm
6051-42-43	EVWO 42 L	42 mm
6551-06-07	EVWO 6 S	6 mm
6551-08-09	EVWO 8 S	8 mm
6551-10-11	EVWO 10 S	10 mm
6551-12-13	EVWO 12 S	12 mm
6551-14-15	EVWO 14 S	14 mm
6551-16-17	EVWO 16 S	16 mm
6551-20-21	EVWO 20 S	20 mm
6551-25-26	EVWO 25 S	25 mm
6551-30-31	EVWO 30 S	30 mm
6551-38-39	EVWO 38 S	38 mm

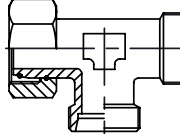

**6071/6571**  
**EVL-0**  
 Adjustable L-fitting with O-ring  
 Body  
**PRODUCT GROUP 600**

Part number	Type	Pipe size
6071-06-07	EVL 6 L	6 mm
6071-08-09	EVL 8 L	8 mm
6071-10-11	EVL 10 L	10 mm
6071-12-13	EVL 12 L	12 mm
6071-15-16	EVL 15 L	15 mm
6071-18-19	EVL 18 L	18 mm
6071-22-23	EVL 22 L	22 mm
6071-28-29	EVL 28 L	28 mm
6071-35-36	EVL 35 L	35 mm
6071-42-43	EVL 42 L	42 mm
6571-06-07	EVL 6 S	6 mm
6571-08-09	EVL 8 S	8 mm
6571-10-11	EVL 10 S	10 mm
6571-12-13	EVL 12 S	12 mm
6571-14-15	EVL 14 S	14 mm
6571-16-17	EVL 16 S	16 mm
6571-20-21	EVL 20 S	20 mm
6571-25-26	EVL 25 S	25 mm
6571-30-31	EVL 30 S	30 mm
6571-38-39	EVL 38 S	38 mm

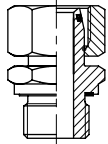

**6090/6590**

**EVGEO – G/ED**

Straight standpipe  
with pre-assembled nut and O-ring  
ISO 1179-2  
PRODUCT GROUP 600

Part number	Type	Pipe size	Thread
6090-06-02	EVGEO 6 L	6 mm	G 1/8"
6090-06-04	EVGEO 6 L	6 mm	G 1/4"
6090-08-04	EVGEO 8 L	8 mm	G 1/4"
6090-10-04	EVGEO 10 L	10 mm	G 1/4"
6090-10-06	EVGEO 10 L	10 mm	G 3/8"
6090-12-04	EVGEO 12 L	12 mm	G 1/4"
6090-12-06	EVGEO 12 L	12 mm	G 3/8"
6090-12-08	EVGEO 12 L	12 mm	G 1/2"
6090-15-08	EVGEO 15 L	15 mm	G 1/2"
6090-18-08	EVGEO 18 L	18 mm	G 1/2"
6096-18-12	EVGEO 18 L	18 mm	G 3/4"
6090-22-12	EVGEO 22 L	22 mm	G 3/4"
6090-28-16	EVGEO 28 L	28 mm	G 1"
6090-35-20	EVGEO 35 L	35 mm	G 1 1/4"
6090-42-24	EVGEO 42 L	42 mm	G 1 1/2"
6590-06-04	EVGEO 6 S	6 mm	G 1/4"
6590-08-04	EVGEO 8 S	8 mm	G 1/4"
6590-10-04	EVGEO 10 S	10 mm	G 1/4"
6590-10-06	EVGEO 10 S	10 mm	G 3/8"
6590-12-06	EVGEO 12 S	12 mm	G 3/8"
6590-12-08	EVGEO 12 S	12 mm	G 1/2"
6590-14-08	EVGEO 14 S	14 mm	G 1/2"
6590-16-06	EVGEO 16 S	16 mm	G 3/8"
6590-16-08	EVGEO 16 S	16 mm	G 1/2"
6590-16-12	EVGEO 16 S	16 mm	G 3/4"
6590-20-12	EVGEO 20 S	20 mm	G 3/4"
6590-25-12	EVGEO 25 S	25 mm	G 3/4"
6590-25-16	EVGEO 25 S	25 mm	G 1"
6590-30-20	EVGEO 30 S	30 mm	G 1 1/4"
6590-38-24	EVGEO 38 S	38 mm	G 1 1/2"

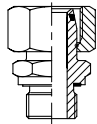

**6092/6592**

**EVGEO – M/ED**

Straight standpipe  
with pre-assembled nut and O-ring  
ISO 9974-2  
PRODUCT GROUP 600

Part number	Type	Pipe size	Thread
6092-06-10	EVGEO 6 L	6 mm	M 10 x 1.0
6092-08-12	EVGEO 8 L	8 mm	M 12 x 1.5
6092-10-14	EVGEO 10 L	10 mm	M 14 x 1.5
6092-12-16	EVGEO 12 L	12 mm	M 16 x 1.5
6092-15-18	EVGEO 15 L	15 mm	M 18 x 1.5
6092-18-22	EVGEO 18 L	18 mm	M 22 x 1.5
6092-22-26	EVGEO 22 L	22 mm	M 26 x 1.5
6092-28-33	EVGEO 28 L	28 mm	M 33 x 2.0
6092-35-42	EVGEO 35 L	35 mm	M 42 x 2.0
6092-42-48	EVGEO 42 L	42 mm	M 48 x 2.0
6592-06-12	EVGEO 6 S	6 mm	M 12 x 1.5
6592-08-14	EVGEO 8 S	8 mm	M 14 x 1.5
6592-10-16	EVGEO 10 S	10 mm	M 16 x 1.5
6592-12-18	EVGEO 12 S	12 mm	M 18 x 1.5
6592-14-20	EVGEO 14 S	14 mm	M 20 x 1.5
6592-16-22	EVGEO 16 S	16 mm	M 22 x 1.5
6592-20-27	EVGEO 20 S	20 mm	M 27 x 2.0
6592-25-33	EVGEO 25 S	25 mm	M 33 x 2.0
6592-30-42	EVGEO 30 S	30 mm	M 42 x 2.0
6592-38-48	EVGEO 38 S	38 mm	M 48 x 2.0

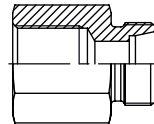

**6101/6601**

**GAI – G**

Straight fitting – G F  
Body

PRODUCT GROUP 600

Part number	Type	Pipe size	Thread
6101-06-03	GAI 6 L	6 mm	G 1/8"
6101-08-05	GAI 8 L	8 mm	G 1/4"
6101-08-07	GAI 8 L	8 mm	G 3/8"
6101-10-05	GAI 10 L	10 mm	G 1/4"
6101-12-05	GAI 12 L	12 mm	G 1/4"
6101-12-07	GAI 12 L	12 mm	G 3/8"
6101-12-09	GAI 12 L	12 mm	G 1/2"
6101-15-09	GAI 15 L	15 mm	G 1/2"
6101-18-09	GAI 18 L	18 mm	G 1/2"
6101-22-13	GAI 22 L	22 mm	G 3/4"
6101-28-17	GAI 28 L	28 mm	G 1"
6101-35-21	GAI 35 L	35 mm	G 1 1/4"
6101-42-25	GAI 42 L	42 mm	G 1 1/2"
6601-06-05	GAI 6 S	6 mm	G 1/4"
6601-08-05	GAI 8 S	8 mm	G 1/4"
6601-10-07	GAI 10 S	10 mm	G 3/8"
6601-12-07	GAI 12 S	12 mm	G 3/8"
6601-14-09	GAI 14 S	14 mm	G 1/2"
6601-16-09	GAI 16 S	16 mm	G 1/2"
6601-20-13	GAI 20 S	20 mm	G 3/4"
6601-25-17	GAI 25 S	25 mm	G 1"
6601-30-21	GAI 30 S	30 mm	G 1 1/4"
6601-38-25	GAI 38 S	38 mm	G 1 1/2"

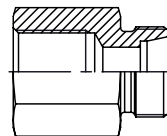

**6102/6602**

**GAI – M**

Straight fitting – M F  
Body

PRODUCT GROUP 600

Part number	Type	Pipe size	Thread
6102-06-11	GAI 6 L	6 mm	M 10 x 1.0
6102-08-13	GAI 8 L	8 mm	M 12 x 1.5
6102-10-15	GAI 10 L	10 mm	M 14 x 1.5
6102-12-17	GAI 12 L	12 mm	M 16 x 1.5
6102-15-19	GAI 15 L	15 mm	M 18 x 1.5
6102-18-23	GAI 18 L	18 mm	M 22 x 1.5
6102-22-27	GAI 22 L	22 mm	M 26 x 1.5
6602-06-13	GAI 6 S	6 mm	M 12 x 1.5
6602-08-15	GAI 8 S	8 mm	M 14 x 1.5
6602-10-17	GAI 10 S	10 mm	M 16 x 1.5
6602-12-19	GAI 12 S	12 mm	M 18 x 1.5
6602-14-21	GAI 14 S	14 mm	M 20 x 1.5
6602-16-23	GAI 16 S	16 mm	M 22 x 1.5
6602-20-28	GAI 20 S	20 mm	M 27 x 2.0





**6103/6603**  
**MAV – G**  
 Manometer fitting  
 Body  
**PRODUCT GROUP 600**

Part number	Type	Pipe size	Thread
6103-06-05	MAV 6 L	6 mm	G 1/4"
6103-08-05	MAV 8 L	8 mm	G 1/4"
6103-10-05	MAV 10 L	10 mm	G 1/4"
6103-12-05	MAV 12 L	12 mm	G 1/4"
6603-06-09	MAV 6 S	6 mm	G 1/2"
6603-08-05	MAV 8 S	8 mm	G 1/4"
6603-08-09	MAV 8 S	8 mm	G 1/2"
6603-10-09	MAV 10 S	10 mm	G 1/2"
6603-12-09	MAV 12 S	12 mm	G 1/2"
6103-13-04	Sealing ring		G 1/4"
6603-13-06	Copper seal		G 3/8"
6603-13-08	Sealing ring		G 1/2"



**6105/6605**  
**RED**  
 Reduction  
 Body  
**PRODUCT GROUP 600**

Part number	Type	Pipe size
6105-08-07	RED 8/6 L	8 mm-6 mm
6105-10-07	RED 10/6 L	10 mm-6 mm
6105-10-09	RED 10/8 L	10 mm-8 mm
6105-12-07	RED 12/6 L	12 mm-6 mm
6105-12-09	RED 12/8 L	12 mm-8 mm
6105-12-11	RED 12/10 L	12 mm-10 mm
6105-15-07	RED 15/6 L	15 mm-6 mm
6105-15-09	RED 15/8 L	15 mm-8 mm
6105-15-11	RED 15/10 L	15 mm-10 mm
6105-15-13	RED 15/12 L	15 mm-12 mm
6105-18-09	RED 18/8 L	18 mm-8 mm
6105-18-11	RED 18/10 L	18 mm-10 mm
6105-18-13	RED 18/12 L	18 mm-12 mm
6105-18-16	RED 18/15 L	18 mm-15 mm
6105-22-13	RED 22/12 L	22 mm-12 mm
6105-22-16	RED 22/15 L	22 mm-15 mm
6105-22-19	RED 22/18 L	22 mm-18 mm
6105-28-11	RED 28/10 L	28 mm-10 mm
6105-28-16	RED 28/15 L	28 mm-15 mm
6105-28-19	RED 28/18 L	28 mm-18 mm
6105-28-23	RED 28/22 L	28 mm-22 mm
6105-35-23	RED 35/22 L	35 mm-22 mm
6105-35-29	RED 35/28 L	35 mm-28 mm

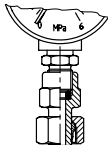

**6204/6704**  
**MAVO-EV G**  
 Pre-assembled manometer fitting  
 with O-ring  
 Complete  
**PRODUCT GROUP 600**

Part number	Type	Pipe size	Thread
6204-06-04	MAV-EV 6 L	6 mm	G 1/4"
6204-08-04	MAV-EV 8 L	8 mm	G 1/4"
6204-10-04	MAV-EV 10 L	10 mm	G 1/4"
6204-12-04	MAV-EV 12 L	12 mm	G 1/4"
6704-06-08	MAV-EV 6 S	6 mm	G 1/2"
6704-08-08	MAV-EV 8 S	8 mm	G 1/2"
6704-10-08	MAV-EV 10 S	10 mm	G 1/2"
6704-12-08	MAV-EV 12 S	12 mm	G 1/2"

6605-08-07	RED 8/6 S	8 mm-6 mm
6605-10-07	RED 10/6 S	10 mm-6 mm
6605-10-09	RED 10/8 S	10 mm-8 mm
6605-12-07	RED 12/6 S	12 mm-6 mm
6605-12-09	RED 12/8 S	12 mm-8 mm
6605-12-11	RED 12/10 S	12 mm-10 mm
6605-14-11	RED 14/10 S	14 mm-10 mm
6605-14-13	RED 14/12 S	14 mm-12 mm
6605-16-11	RED 16/10 S	16 mm-10 mm
6605-16-13	RED 16/12 S	16 mm-12 mm
6605-16-15	RED 16/14 S	16 mm-14 mm
6605-20-11	RED 20/10 S	20 mm-10 mm
6605-20-13	RED 20/12 S	20 mm-12 mm
6605-20-15	RED 20/14 S	20 mm-14 mm
6605-20-17	RED 20/16 S	20 mm-16 mm
6605-25-17	RED 25/16 S	25 mm-16 mm
6605-25-21	RED 25/20 S	25 mm-20 mm
6605-30-21	RED 30/20 S	30 mm-20 mm
6605-30-26	RED 30/25 S	30 mm-25 mm
6605-38-26	RED 38/25 S	38 mm-25 mm
6605-38-31	RED 38/30 S	38 mm-30 mm

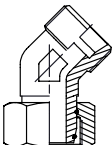

**6055/6555**  
**EV-O**  
 Adjustable 45° elbow fitting with O-ring  
 Body  
**PRODUCT GROUP 600**

Part number	Type	Pipe size
6055-06-07	EV 6 L	6 mm
6055-08-09	EV 8 L	8 mm
6055-10-11	EV 10 L	10 mm
6055-12-13	EV 12 L	12 mm
6055-15-16	EV 15 L	15 mm
6055-18-19	EV 18 L	18 mm
6055-22-23	EV 22 L	22 mm
6055-28-29	EV 28 L	28 mm
6055-35-36	EV 35 L	35 mm
6055-42-43	EV 42 L	42 mm
6555-06-07	EV 6 S	6 mm
6555-08-09	EV 8 S	8 mm
6555-10-11	EV 10 S	10 mm
6555-12-13	EV 12 S	12 mm
6555-14-15	EV 14 S	14 mm
6555-16-17	EV 16 S	16 mm
6555-20-21	EV 20 S	20 mm
6555-25-26	EV 25 S	25 mm
6555-30-31	EV 30 S	30 mm
6555-38-39	EV 38 S	38 mm

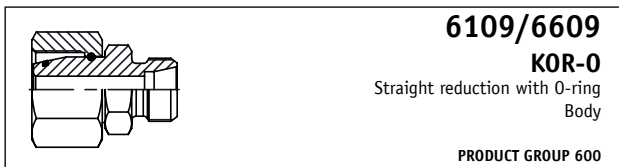

Part number	Type	Pipe size
6109-08-07	KOR O 8/6 L	8 mm-6 mm
6109-10-07	KOR O 10/6 L	10 mm-6 mm
6109-10-09	KOR O 10/8 L	10 mm-8 mm
6109-12-07	KOR O 12/6 L	12 mm-6 mm
6109-12-09	KOR O 12/8 L	12 mm-8 mm
6109-12-11	KOR O 12/10 L	12 mm-10 mm
6109-15-07	KOR O 15/6 L	15 mm-6 mm
6109-15-09	KOR O 15/8 L	15 mm-8 mm
6109-15-11	KOR O 15/10 L	15 mm-10 mm
6109-15-13	KOR O 15/12 L	15 mm-12 mm
6109-18-07	KOR O 18/6 L	18 mm-6 mm
6109-18-09	KOR O 18/8 L	18 mm-8 mm
6109-18-11	KOR O 18/10 L	18 mm-10 mm
6109-18-13	KOR O 18/12 L	18 mm-12 mm
6109-18-16	KOR O 18/15 L	18 mm-15 mm
6109-22-07	KOR O 22/6 L	22 mm-6 mm
6109-22-09	KOR O 22/8 L	22 mm-8 mm
6109-22-11	KOR O 22/10 L	22 mm-10 mm
6109-22-13	KOR O 22/12 L	22 mm-12 mm
6109-22-16	KOR O 22/15 L	22 mm-15 mm
6109-22-19	KOR O 22/18 L	22 mm-18 mm
6109-28-07	KOR O 28/6 L	28 mm-6 mm
6109-28-09	KOR O 28/8 L	28 mm-8 mm
6109-28-11	KOR O 28/10 L	28 mm-10 mm
6109-28-13	KOR O 28/12 L	28 mm-12 mm
6109-28-16	KOR O 28/15 L	28 mm-15 mm
6109-28-19	KOR O 28/18 L	28 mm-18 mm
6109-28-23	KOR O 28/22 L	28 mm-22 mm
6109-35-07	KOR O 35/6 L	35 mm-6 mm
6109-35-09	KOR O 35/8 L	35 mm-8 mm
6109-35-11	KOR O 35/10 L	35 mm-10 mm
6109-35-13	KOR O 35/12 L	35 mm-12 mm
6109-35-16	KOR O 35/15 L	35 mm-15 mm
6109-35-19	KOR O 35/18 L	35 mm-18 mm
6109-35-23	KOR O 35/22 L	35 mm-22 mm
6109-35-29	KOR O 35/28 L	35 mm-28 mm
6109-42-07	KOR O 42/6 L	42 mm-6 mm
6109-42-09	KOR O 42/8 L	42 mm-8 mm
6109-42-11	KOR O 42/10 L	42 mm-10 mm
6109-42-13	KOR O 42/12 L	42 mm-12 mm
6109-42-16	KOR O 42/15 L	42 mm-15 mm
6109-42-19	KOR O 42/18 L	42 mm-18 mm
6109-42-23	KOR O 42/22 L	42 mm-22 mm
6109-42-29	KOR O 42/28 L	42 mm-28 mm
6109-42-36	KOR O 42/35 L	42 mm-35 mm
6609-08-07	KOR O 8/6 S	8 mm-6 mm
6609-10-07	KOR O 10/6 S	10 mm-6 mm
6609-10-09	KOR O 10/8 S	10 mm- 8 mm
6609-12-07	KOR O 12/6 S	12 mm-6 mm
6609-12-09	KOR O 12/8 S	12 mm-8 mm
6609-12-11	KOR O12/10 S	12 mm-10 mm
6609-14-07	KOR O 14/6 S	14 mm-6 mm
6609-14-09	KOR O 14/8 S	14 mm-8 mm
6609-14-11	KOR O 14/10 S	14 mm-10 mm
6609-14-13	KOR O 14/12 S	14 mm-12 mm
6609-16-07	KOR O 16/6 S	16 mm-6 mm
6609-16-09	KOR O 16/8 S	16 mm-8 mm
6609-16-11	KOR O 16/10 S	16 mm-10 mm
6609-16-13	KOR O 16/12 S	16 mm-12 mm
6609-16-15	KOR O 16/14 S	16 mm-14 mm
6609-20-07	KOR O 20/6 S	20 mm-6 mm

Part number	Type	Pipe size
6609-20-09	KOR O 20/8 S	20 mm-8 mm
6609-20-11	KOR O 20/10 S	20 mm-10 mm
6609-20-13	KOR O 20/12 S	20 mm-12 mm
6609-20-15	KOR O 20/14 S	20 mm-14 mm
6609-20-17	KOR O 20/16 S	20 mm-16 mm
6609-25-07	KOR O 25/6 S	25 mm-6 mm
6609-25-09	KOR O 25/8 S	25 mm-8 mm
6609-25-11	KOR O 25/10 S	25 mm-10 mm
6609-25-13	KOR O 25/12 S	25 mm-12 mm
6609-25-15	KOR O 25/14 S	25 mm-14 mm
6609-25-17	KOR O 25/16 S	25 mm-16 mm
6609-25-21	KOR O 25/20 S	25 mm-20 mm
6609-30-09	KOR O 30/8 S	30 mm-8 mm
6609-30-11	KOR O 30/10 S	30 mm-10 mm
6609-30-13	KOR O 30/12 S	30 mm-12 mm
6609-30-17	KOR O 30/16 S	30 mm-16 mm
6609-30-21	KOR O 30/20 S	30 mm-20 mm
6609-30-26	KOR O 30/25 S	30 mm-25 mm
6609-38-09	KOR O 38/8 S	38 mm-8 mm
6609-38-13	KOR O 38/12 S	38 mm-12 mm
6609-38-17	KOR O 38/16 S	38 mm-16 mm
6609-38-21	KOR O 38/20 S	38 mm-20 mm
6609-38-26	KOR O 38/25 S	38 mm-25 mm
6609-38-31	KOR O 38/30 S	38 mm-30 mm

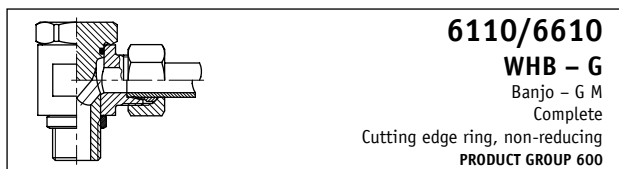

Part number	Type	Pipe size	Thread
6110-06-02	WHB 6 L	6 mm	G 1/8"
6110-08-04	WHB 8 L	8 mm	G 1/4"
6110-10-04	WHB 10 L	10 mm	G 1/4"
6110-12-04	WHB 12 L	12 mm	G 1/4"
6110-12-06	WHB 12 L	12 mm	G 3/8"
6110-15-08	WHB 15 L	15 mm	G 1/2"
6110-18-08	WHB 18 L	18 mm	G 1/2"
6110-22-12	WHB 22 L	22 mm	G 3/4"
6110-28-16	WHB 28 L	28 mm	G 1"
6110-35-20	WHB 35 L	35 mm	G 1 1/4"
6110-42-24	WHB 42 L	42 mm	G 1 1/2"
6610-06-04	WHB 6 S	6 mm	G 1/4"
6610-08-04	WHB 8 S	8 mm	G 1/4"
6610-10-06	WHB 10 S	10 mm	G 3/8"
6610-12-06	WHB 12 S	12 mm	G 3/8"
6610-14-08	WHB 14 S	14 mm	G 1/2"
6610-16-08	WHB 16 S	16 mm	G 1/2"
6610-20-12	WHB 20 S	20 mm	G 3/4"
6610-25-16	WHB 25 S	25 mm	G 1"
6610-30-20	WHB 30 S	30 mm	G 1 1/4"
6610-38-24	WHB 38 S	38 mm	G 1 1/2"



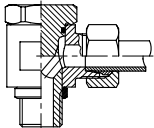

**6111/6611**  
**WHB-M**  
 Banjo - M M  
 Cutting edge ring, non-reducing  
**PRODUCT GROUP 600**

Part number	Type	Pipe size	Thread
6111-06-10	WHB 6 L	6 mm	M10 x 1,0
6111-08-12	WHB 8 L	8 mm	M12 x 1,5
6111-10-14	WHB 10 L	10 mm	M14 x 1,5
6111-12-16	WHB 12 L	12 mm	M16 x 1,5
6111-15-18	WHB 15 L	15 mm	M18 x 1,5
6111-18-22	WHB 18 L	18 mm	M22 x 1,5
6111-22-26	WHB 22 L	22 mm	M26 x 1,5
6111-28-33	WHB 28 L	28 mm	M33 x 2,0
6111-35-42	WHB 35 L	35 mm	M42 x 2,0
6111-42-48	WHB 42 L	42 mm	M48 x 2,0
6611-06-12	WHB 6 S	6 mm	M12 x 1,5
6611-08-14	WHB 8 S	8 mm	M14 x 1,5
6611-10-16	WHB 10 S	10 mm	M16 x 1,5
6611-12-18	WHB 12 S	12 mm	M18 x 1,5
6611-16-22	WHB 16 S	16 mm	M22 x 1,5
6611-20-27	WHB 20 S	20 mm	M27 x 2,0
6611-25-33	WHB 25 S	25 mm	M33 x 2,0
6611-30-42	WHB 30 S	30 mm	M42 x 2,0
6611-38-48	WHB 38 S	38 mm	M48 x 2,0

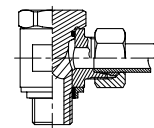

**6119/6619**  
**WHO - M**  
 Banjo - M M  
 Soft seal, teflon, non-reducing  
**PRODUCT GROUP 600**

Part number	Type	Pipe size	Thread
6119-06-10	WHO 6 L	6 mm	M10 x 1,0
6119-08-12	WHO 8 L	8 mm	M12 x 1,5
6119-10-14	WHO 10 L	10 mm	M14 x 1,5
6119-12-16	WHO 12 L	12 mm	M16 x 1,5
6119-15-18	WHO 15 L	15 mm	M18 x 1,5
6119-18-22	WHO 18 L	18 mm	M22 x 1,5
6119-22-26	WHO 22 L	22 mm	M26 x 1,5
6619-06-12	WHO 6 S	6 mm	M12 x 1,5
6619-08-14	WHO 8 S	8 mm	M14 x 1,5
6619-10-16	WHO 10 S	10 mm	M16 x 1,5
6619-12-18	WHO 12 S	12 mm	M18 x 1,5
6619-14-20	WHO 14 S	14 mm	M20 x 1,5
6619-16-22	WHO 16 S	16 mm	M22 x 1,5
6619-20-27	WHO 20 S	20 mm	M27 x 2,0

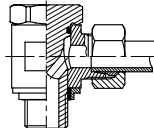

**6118/6618**  
**WHO - G**  
 Banjo - G M  
 Complete  
 Soft seal, teflon, non-reducing  
**PRODUCT GROUP 600**

Part number	Type	Pipe size	Thread
6118-06-02	WHO 6 L	6 mm	G 1/8"
6118-08-04	WHO 8 L	8 mm	G 1/4"
6118-10-04	WHO 10 L	10 mm	G 1/4"
6118-12-06	WHO 12 L	12 mm	G 3/8"
6118-15-08	WHO 15 L	15 mm	G 1/2"
6118-18-08	WHO 18 L	18 mm	G 1/2"
6118-22-12	WHO 22 L	22 mm	G 3/4"
6618-06-04	WHO 6 S	6 mm	G 1/4"
6618-08-04	WHO 8 S	8 mm	G 1/4"
6618-10-06	WHO 10 S	10 mm	G 3/8"
6618-12-06	WHO 12 S	12 mm	G 3/8"
6618-14-08	WHO 14 S	14 mm	G 1/2"
6618-16-08	WHO 16 S	16 mm	G 1/2"
6618-25-16	WHO 25 S	25 mm	G 1"
6618-30-20	WHO 30 S	30 mm	G 1 1/4"

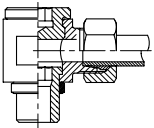

**6112/6612**  
**DSVW - G**  
 Banjo - M M  
 Collar screw  
 Cutting edge ring, non-reducing  
**PRODUCT GROUP 600**

Part number	Type	Pipe size	Thread
6112-06-02	DSVW 6 L	6 mm	G 1/8"
6112-08-04	DSVW 8 L	8 mm	G 1/4"
6112-10-04	DSVW 10 L	10 mm	G 1/4"
6112-12-06	DSVW 12 L	12 mm	G 3/8"
6112-15-08	DSVW 15 L	15 mm	G 1/2"
6112-18-08	DSVW 18 L	18 mm	G 1/2"
6112-22-12	DSVW 22 L	22 mm	G 3/4"
6112-28-16	DSVW 28 L	28 mm	G 1"
6112-35-20	DSVW 35 L	35 mm	G 1 1/4"
6112-42-24	DSVW 42 L	42 mm	G 1 1/2"
6612-06-04	DSVW 6 S	6 mm	G 1/4"
6612-08-04	DSVW 8 S	8 mm	G 1/4"
6612-10-06	DSVW 10 S	10 mm	G 3/8"
6612-12-06	DSVW 12 S	12 mm	G 3/8"
6612-14-08	DSVW 14 S	14 mm	G 1/2"
6612-16-08	DSVW 16 S	16 mm	G 1/2"
6612-20-12	DSVW 20 S	20 mm	G 3/4"
6612-25-16	DSVW 25 S	25 mm	G 1"

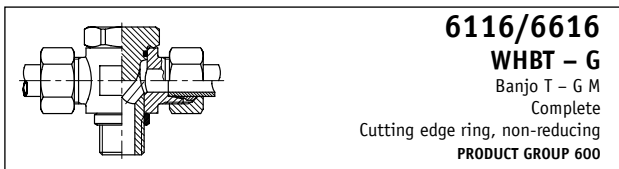

**6116/6616**  
**WHBT – G**  
 Banjo T – G M  
 Complete  
 Cutting edge ring, non-reducing  
**PRODUCT GROUP 600**

Part number	Type	Pipe size	Thread
6116-06-02	WHBT 6 L	6 mm	1/8"
6116-08-04	WHBT 8 L	8 mm	1/4"
6116-10-04	WHBT 10 L	10 mm	1/4"
6116-12-06	WHBT 12 L	12 mm	3/8"
6116-15-08	WHBT 15 L	15 mm	1/2"
6116-18-08	WHBT 18 L	18 mm	1/2"
6116-22-12	WHBT 22 L	22 mm	3/4"
6116-28-16	WHBT 28 L	28 mm	1"
6116-35-20	WHBT 35 L	35 mm	1 1/4"
6116-42-24	WHBT 42 L	42 mm	1 1/2"
6616-06-04	WHBT 6 S	6 mm	1/4"
6616-08-04	WHBT 8 S	8 mm	1/4"
6616-10-06	WHBT 10 S	10 mm	3/8"
6616-12-06	WHBT 12 S	12 mm	3/8"
6616-14-08	WHBT 14 S	14 mm	1/2"
6616-16-08	WHBT 16 S	16 mm	1/2"
6616-20-12	WHBT 20 S	20 mm	3/4"
6616-25-16	WHBT 25 S	25 mm	1"
6616-30-20	WHBT 30 S	30 mm	1 1/4"
6616-38-24	WHBT 38 S	38 mm	1 1/2"

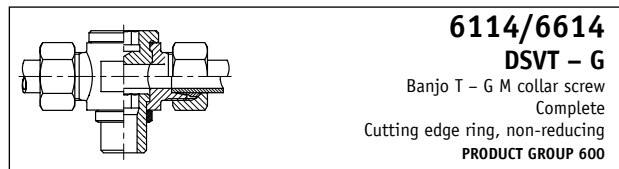

**6114/6614**  
**DSVT – G**  
 Banjo T – G M collar screw  
 Complete  
 Cutting edge ring, non-reducing  
**PRODUCT GROUP 600**

Part number	Type	Pipe size	Thread
6114-06-02	DSVT 6 L	6 mm	1/8"
6114-08-04	DSVT 8 L	8 mm	1/4"
6114-10-04	DSVT 10 L	10 mm	1/4"
6114-12-06	DSVT 12 L	12 mm	3/8"
6114-15-08	DSVT 15 L	15 mm	1/2"
6114-18-08	DSVT 18 L	18 mm	1/2"
6114-22-12	DSVT 22 L	22 mm	3/4"
6114-28-16	DSVT 28 L	28 mm	1"
6114-35-20	DSVT 35 L	35 mm	1 1/4"
6114-42-24	DSVT 42 L	42 mm	1 1/2"
6614-06-04	DSVT 6 S	6 mm	1/4"
6614-08-04	DSVT 8 S	8 mm	1/4"
6614-10-06	DSVT 10 S	10 mm	3/8"
6614-12-06	DSVT 12 S	12 mm	3/8"
6614-14-08	DSVT 14 S	14 mm	1/2"
6614-16-08	DSVT 16 S	16 mm	1/2"
6614-20-12	DSVT 20 S	20 mm	3/4"
6614-25-16	DSVT 25 S	25 mm	1"
6614-30-20	DSVT 30 S	30 mm	1 1/4"
6614-38-24	DSVT 38 S	38 mm	1 1/2"

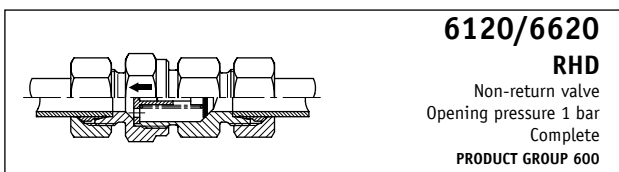

**6120/6620**  
**RHD**  
 Non-return valve  
 Opening pressure 1 bar  
 Complete  
**PRODUCT GROUP 600**

Part number	Type	Pipe size
6120-06-06	RHD 6 L	6 mm
6120-08-08	RHD 8 L	8 mm
6120-10-10	RHD 10 L	10 mm
6120-12-12	RHD 12 L	12 mm
6120-15-15	RHD 15 L	15 mm
6120-18-18	RHD 18 L	18 mm
6120-22-22	RHD 22 L	22 mm
6120-28-28	RHD 28 L	28 mm
6120-35-35	RHD 35 L	35 mm
6120-42-42	RHD 42 L	42 mm
6620-06-06	RHD 6 S	6 mm
6620-08-08	RHD 8 S	8 mm
6620-10-10	RHD 10 S	10 mm
6620-12-12	RHD 12 S	12 mm
6620-14-14	RHD 14 S	14 mm
6620-16-16	RHD 16 S	16 mm
6620-20-20	RHD 20 S	20 mm
6620-25-25	RHD 25 S	25 mm
6620-30-30	RHD 30 S	30 mm
6620-38-38	RHD 38 S	38 mm



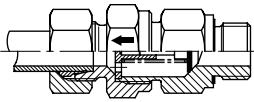

**6121/6621**

**RHV – G**

Non-return valve  
Opening pressure 1 bar  
Complete, ED-seal  
PRODUCT GROUP 600

Part number	Type	Pipe size	Thread
6121-06-02	RHV 6 L	6 mm	G 1/8"
6121-08-04	RHV 8 L	8 mm	G 1/4"
6121-10-04	RHV 10 L	10 mm	G 1/4"
6121-12-06	RHV 12 L	12 mm	G 3/8"
6121-15-08	RHV 15 L	15 mm	G 1/2"
6121-18-08	RHV 18 L	18 mm	G 1/2"
6121-22-12	RHV 22 L	22 mm	G 3/4"
6121-28-16	RHV 28 L	28 mm	G 1"
6121-35-20	RHV 35 L	35 mm	G 1 1/4"
6121-42-24	RHV 42 L	42 mm	G 1 1/2"
6621-06-04	RHV 6 S	6 mm	G 1/4"
6621-08-04	RHV 8 S	8 mm	G 1/4"
6621-10-06	RHV 10 S	10 mm	G 3/8"
6621-12-06	RHV 12 S	12 mm	G 3/8"
6621-14-08	RHV 14 S	14 mm	G 1/2"
6621-16-08	RHV 16 S	16 mm	G 1/2"
6621-20-12	RHV 20 S	20 mm	G 3/4"
6621-25-16	RHV 25 S	25 mm	G 1"
6621-30-20	RHV 30 S	30 mm	G 1 1/4"
6621-38-24	RHV 38 S	38 mm	G 1 1/2"

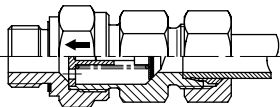

**6123/6623**

**RHZ – G – ED**

Non-return valve  
Opening pressure 1 bar  
Complete  
PRODUCT GROUP 600

Part number	Type	Pipe size	Thread
6123-06-02	RHZ 6 L	6 mm	G 1/8"
6123-08-04	RHZ 8 L	8 mm	G 1/4"
6123-10-04	RHZ 10 L	10 mm	G 1/4"
6123-12-06	RHZ 12 L	12 mm	G 3/8"
6123-15-08	RHZ 15 L	15 mm	G 1/2"
6123-18-08	RHZ 18 L	18 mm	G 1/2"
6123-22-12	RHZ 22 L	22 mm	G 3/4"
6123-28-16	RHZ 28 L	28 mm	G 1"
6123-35-20	RHZ 35 L	35 mm	G 1 1/4"
6123-42-24	RHZ 42 L	42 mm	G 1 1/2"
6623-06-04	RHZ 6 S	6 mm	G 1/4"
6623-08-04	RHZ 8 S	8 mm	G 1/4"
6623-10-06	RHZ 10 S	10 mm	G 3/8"
6623-12-06	RHZ 12 S	12 mm	G 3/8"
6623-14-08	RHZ 14 S	14 mm	G 1/2"
6623-16-08	RHZ 16 S	16 mm	G 1/2"
6623-20-12	RHZ 20 S	20 mm	G 3/4"
6623-25-16	RHZ 25 S	25 mm	G 1"
6623-30-20	RHZ 30 S	30 mm	G 1 1/4"
6623-38-24	RHZ 38 S	38 mm	G 1 1/2"

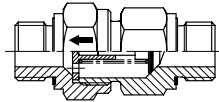

**6126**

**RHR**

Non-return valve  
Opening pressure 1 bar  
Complete, ED-seal  
PRODUCT GROUP 600

Part number	Type	Thread
6126-04-04	RHR	G 1/4" M
6126-06-06	RHR	G 3/8" M
6126-08-08	RHR	G 1/2" M
6126-12-12	RHR	G 3/4" M
6126-16-16	RHR	G 1" M

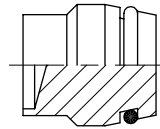

**6130/6630**

**PL**  
Plug

PRODUCT GROUP 600

Part number	Type	Pipe size
6130-00-06	PL 6 L/S	6 mm
6130-00-08	PL 8 L/S	8 mm
6130-00-10	PL 10 L/S	10 mm
6130-00-12	PL 12 L/S	12 mm
6130-00-15	PL 15 L	15 mm
6130-00-18	PL 18 L	18 mm
6130-00-22	PL 22 L	22 mm
6130-00-28	PL 28 L	28 mm
6130-00-35	PL 35 L	35 mm
6130-00-42	PL 42 L	42 mm
6630-00-14	PL 14 S	14 mm
6630-00-16	PL 16 S	16 mm
6630-00-20	PL 20 S	20 mm
6630-00-25	PL 25 S	25 mm
6630-00-30	PL 30 S	30 mm
6630-00-38	PL 38 S	38 mm

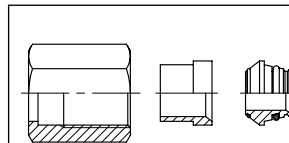

**6131/6631**

**Adaptor kit**

For cutting ring fittings  
to collar 37° cone

PRODUCT GROUP 600

Part number	Type	Pipe size
6131-00-06	HOA 6 L	6 mm
6131-00-08	HOA 8 L	8 mm
6131-00-10	HOA 10 L	10 mm
6131-00-12	HOA 12 L	12 mm
6131-00-15	HOA 15 L	15 mm
6131-00-18	HOA 18 L	18 mm
6131-00-22	HOA 22 L	22 mm
6131-00-28	HOA 28 L	28 mm
6131-00-35	HOA 35 L	35 mm
6131-00-42	HOA 42 L	42 mm
6631-00-06	HOA 6 S	6 mm
6631-00-08	HOA 8 S	8 mm
6631-00-10	HOA 10 S	10 mm
6631-00-12	HOA 12 S	12 mm
6631-00-14	HOA 14 S	14 mm
6631-00-16	HOA 16 S	16 mm
6631-00-20	HOA 20 S	20 mm
6631-00-25	HOA 25 S	25 mm
6631-00-30	HOA 30 S	30 mm
6631-00-38	HOA 38 S	38 mm

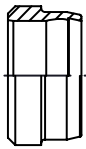

**6149/6649**

**D**  
Cutting ring

PRODUCT GROUP 600

Part number	Type	Pipe size
6149-01-06	D 6 L/S	6 mm
6149-01-08	D 8 L/S	8 mm
6149-01-10	D 10 L/S	10 mm
6149-01-12	D 12 L/S	12 mm
6149-01-15	D 15 L	15 mm
6149-01-18	D 18 L	18 mm
6149-01-22	D 22 L	22 mm
6149-01-28	D 28 L	28 mm
6149-01-35	D 35 L	35 mm
6149-01-42	D 42 L	42 mm
6649-01-14	D 14 S	14 mm
6649-01-16	D 16 S	16 mm
6649-01-20	D 20 S	20 mm
6649-01-25	D 25 S	25 mm
6649-01-30	D 30 S	30 mm
6649-01-38	D 38 S	38 mm

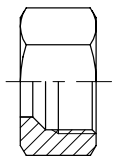

**6150/6650**

**M**  
Nut

PRODUCT GROUP 600

Part number	Type	Pipe size	Thread
6150-00-06	M 6 L	6 mm	M 12 x 1.5
6150-00-08	M 8 L	8 mm	M 14 x 1.5
6150-00-10	M 10 L	10 mm	M 16 x 1.5
6150-00-12	M 12 L	12 mm	M 18 x 1.5
6150-00-15	M 15 L	15 mm	M 22 x 1.5
6150-00-18	M 18 L	18 mm	M 26 x 1.5
6150-00-22	M 22 L	22 mm	M 30 x 2.0
6150-00-28	M 28 L	28 mm	M 36 x 2.0
6150-00-35	M 35 L	35 mm	M 45 x 2.0
6150-00-42	M 42 L	42 mm	M 52 x 2.0
6650-00-06	M 6 S	6 mm	M 14 x 1.5
6650-00-08	M 8 S	8 mm	M 16 x 1.5
6650-00-10	M 10 S	10 mm	M 18 x 1.5
6650-00-12	M 12 S	12 mm	M 20 x 1.5
6650-00-14	M 14 S	14 mm	M 22 x 1.5
6650-00-16	M 16 S	16 mm	M 24 x 1.5
6650-00-20	M 20 S	20 mm	M 30 x 2.0
6650-00-25	M 25 S	25 mm	M 36 x 2.0
6650-00-30	M 30 S	30 mm	M 42 x 2.0
6650-00-38	M 38 S	38 mm	M 52 x 2.0

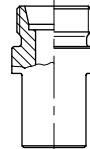

**6151/6651**

**FM**  
Pre-installation die

PRODUCT GROUP 900

Part number	Type	Pipe size
6151-00-06	FM 6 L	6 mm
6151-00-08	FM 8 L	8 mm
6151-00-10	FM 10 L	10 mm
6151-00-12	FM 12 L	12 mm
6151-00-15	FM 15 L	15 mm
6151-00-18	FM 18 L	18 mm
6151-00-22	FM 22 L	22 mm
6151-00-28	FM 28 L	28 mm
6151-00-35	FM 35 L	35 mm
6151-00-42	FM 42 L	42 mm
6651-00-06	FM 6 S	6 mm
6651-00-08	FM 8 S	8 mm
6651-00-10	FM 10 S	10 mm
6651-00-12	FM 12 S	12 mm
6651-00-14	FM 14 S	14 mm
6651-00-16	FM 16 S	16 mm
6651-00-20	FM 20 S	20 mm
6651-00-25	FM 25 S	25 mm
6651-00-30	FM 30 S	30 mm
6651-00-38	FM 38 S	38 mm

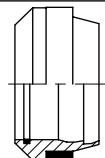

**6152/6652**

**D-ED B4**  
Cutting ring and soft seal for nut

PRODUCT GROUP 600

Part number	Type	Pipe size
6152-03-06	D - ED B4 6 L	6 mm
6152-03-08	D - ED B4 8 L	8 mm
6152-03-10	D - ED B4 10 L	10 mm
6152-03-12	D - ED B4 12 L	12 mm
6152-03-15	D - ED B4 15 L	15 mm
6152-03-18	D - ED B4 18 L	18 mm
6152-03-22	D - ED B4 22 L	22 mm
6152-03-28	D - ED B4 28 L	28 mm
6152-03-35	D - ED B4 35 L	35 mm
6152-03-42	D - ED B4 42 L	42 mm
6652-03-06	D - ED B4 6 S	6 mm
6652-03-08	D - ED B4 8 S	8 mm
6652-03-10	D - ED B4 10 S	10 mm
6652-03-12	D - ED B4 12 S	12 mm
6652-03-14	D - ED B4 14 S	14 mm
6652-03-16	D - ED B4 16 S	16 mm
6652-03-20	D - ED B4 20 S	20 mm
6652-03-25	D - ED B4 25 S	25 mm
6652-03-30	D - ED B4 30 S	30 mm
6652-03-38	D - ED B4 38 S	38 mm







**6153**  
**GM – Locking nut**  
 For type 6045/6046

PRODUCT GROUP 600

Part number	Type	Size	Thread
6153-00-12	Locking nut	6 L	M 12 x 1.5
6153-00-14	Locking nut	8 L/6 S	M 14 x 1.5
6153-00-16	Locking nut	10 L/8 S	M 16 x 1.5
6153-00-18	Locking nut	12 L/10 S	M 18 x 1.5
6153-00-20	Locking nut	12 S	M 20 x 1.5
6153-00-22	Locking nut	15 L/14 S	M 22 x 1.5
6153-00-24	Locking nut	16 S	M 24 x 1.5
6153-00-26	Locking nut	18 S	M 26 x 1.5
6153-00-30	Locking nut	22 L/20 S	M 30 x 2.0
6153-00-36	Locking nut	28 L/25 S	M 36 x 2.0
6153-00-42	Locking nut	30 S	M 42 x 2.0
6153-00-45	Locking nut	35 S	M 45 x 2.0
6153-00-52	Locking nut	42 L/38 S	M 52 x 2.0

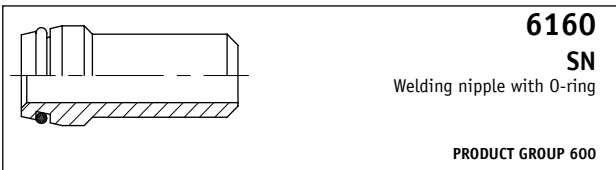

**6160**  
**SN**  
 Welding nipple with O-ring

PRODUCT GROUP 600

Part number	Type	Pipe size	Thickness
6160-06-15	SN 6	6 mm	1.75 mm
6160-08-15	SN 8	8 mm	1.50 mm
6160-10-15	SN 10	10 mm	1.50 mm
6160-10-20	SN 10	10 mm	2.00 mm
6160-12-15	SN 12	12 mm	1.50 mm
6160-12-20	SN 12	12 mm	2.00 mm
6160-12-25	SN 12	12 mm	2.50 mm
6160-16-20	SN 16	16 mm	2.00 mm
6160-16-25	SN 16	16 mm	2.50 mm
6160-16-30	SN 16	16 mm	3.00 mm
6160-20-25	SN 20	20 mm	2.50 mm
6160-20-30	SN 20	20 mm	3.00 mm
6160-20-40	SN 20	20 mm	4.00 mm
6160-22-25	SN 22	22 mm	2.50 mm
6160-25-30	SN 25	25 mm	3.00 mm
6160-25-40	SN 25	25 mm	4.00 mm
6160-30-30	SN 30	30 mm	3.00 mm
6160-30-40	SN 30	30 mm	4.00 mm
6160-30-50	SN 30	30 mm	5.00 mm
6160-38-40	SN 38	38 mm	4.00 mm
6160-38-50	SN 38	38 mm	5.00 mm
6160-42-30	SN 42	42 mm	3.00 mm

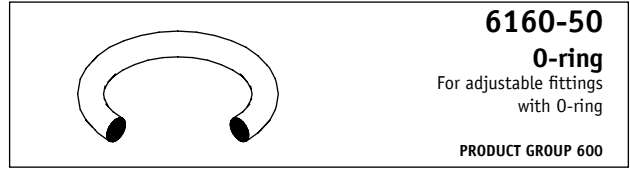

**6160-50**  
**O-ring**  
 For adjustable fittings with O-ring

PRODUCT GROUP 600

Part number	Type	Pipe size
6160-50-06	O-ring SN 6	6 mm
6160-50-08	O-ring SN 8	8 mm
6160-50-10	O-ring SN 10	10 mm
6160-50-12	O-ring SN 12	12 mm
6160-50-16	O-ring SN 16	16 mm
6160-50-20	O-ring SN 20	20 mm
6160-50-25	O-ring SN 25	25 mm
6160-50-30	O-ring SN 30	30 mm
6160-50-38	O-ring SN 38	38 mm

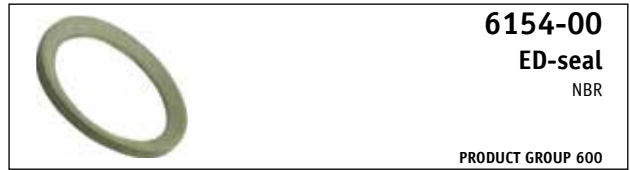

**6154-00**  
**ED-seal**  
 NBR

PRODUCT GROUP 600

Part number	Type	Dim.
6154-00-02	Seal NBR	1/8"
6154-00-04	Seal NBR	1/4"
6154-00-06	Seal NBR	3/8"
6154-00-08	Seal NBR	1/2"
6154-00-12	Seal NBR	3/4"
6154-00-16	Seal NBR	1"
6154-00-20	Seal NBR	1 1/4"
6154-00-24	Seal NBR	1 1/2"

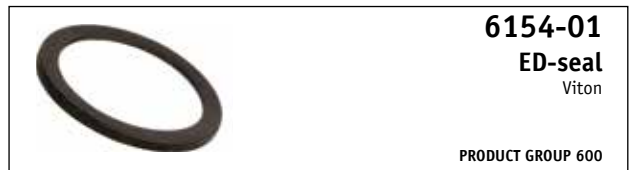

**6154-01**  
**ED-seal**  
 Viton

PRODUCT GROUP 600

Part number	Type	Dim.
6154-01-04	Seal Viton	1/4"
6154-01-06	Seal Viton	3/8"
6154-01-08	Seal Viton	1/2"
6154-01-12	Seal Viton	3/4"
6154-01-16	Seal Viton	1"
6154-01-20	Seal Viton	1 1/4"
6154-01-24	Seal Viton	1 1/2"

# Certified assembly on high pressure hoses - quick deliveries!



[www.hydroscand.com](http://www.hydroscand.com)